

CONTENTS

Snake Eyes® Spanners

MACHINE SCREWS

Pan Head.....	6
Truss Head	7
Flat Head.....	7
Flat Head (Brass)	9
Oval Head	9
Oval Head (Brass).....	10

SHEET METAL SCREWS

Truss Head	10
Pan Head.....	11
Flat Head	11
Oval Head	12

NUTS

Spanner Nuts & Tools	13
Breakaway Nuts	13

Socket Security

CAP SCREWS

Button Head.....	14
Flat Head	15

SHEET METAL SCREWS

Button Head.....	15
------------------	----

TORX® Security

MACHINE SCREWS

Button Head.....	16
Flat Head	17

SHEET METAL & SELF-DRILLING SCREWS

Button Head.....	16
Pan Head (Self-Drilling).....	17
Flat Head	17

Phillips Security

MACHINE SCREWS

Pan Head.....	18
Flat Head	19

SHEET METAL SCREWS

Pan Head.....	20
Flat Head	21

ONE-WAY

MACHINE SCREWS

Round Head	22
Truss Head	22
Oval Head	23
Sex Bolts	24

ONE-WAY

SHEET METAL SCREWS

Round Head	23
Oval Head	24

TRI-WING®

SHEET METAL SCREWS

Pan Head.....	25
---------------	----

MACHINE SCREWS

Pan Head.....	25
---------------	----

OPSIT®

SHEET METAL SCREWS

Truss Head	25
------------------	----

TP3 TRIANGULAR RECESS

SHEET METAL SCREWS



Pan Head.....	25
---------------	----

METRIC



Snake Eyes® Spanners Machine Screws

 Pan Head.....	26
 Oval Head	26
 Flat Head	26

TORX® Security Machine Screws

 Button Head.....	27
 Flat Head	27

Socket Security Machine Screws

 Button Head.....	28
 Flat Head	28

STANDARD TORX (NON-TAMPERPROOF)

SHEET METAL SCREWS

Pan Head.....	28
---------------	----

TOOLS AND KITS

Spanner	29
Tri-Wing	30
Socket Pin-Head	30
Phillips Pin-Head	31
Torx Security	32
One-Way Removal Tools.....	33
TP3	33
Complete Tool Kits.....	34



GENERAL INFORMATION

KEEP UNAUTHORIZED HANDS OFF YOUR EQUIPMENT!

TAMPER-RESISTANT SECURITY SCREWS can save you thousands of dollars—by fighting off pilferage, tampering, or unauthorized adjustments on scores of items.

We offer a complete line of corrosion-resistant security screws designed to prevent vandalism and theft, yet allow easy access by authorized personnel with the matching tools. **These screws are virtually impossible to remove without the special matching screwdrivers.**



CONTACTING TAMPERPROOF

- **ADDRESS** — Tamperproof Screw Co., Inc.,
30 Laurel Street, Hicksville, N.Y. 11801
- **TELEPHONE** — 516-931-1616
- **FAX** — 516-931-1654
- **VISIT OUR WEB SITE** — www.tamperproof.com
- **EMAIL** — sales@tamperproof.com

TERMS AND CONDITIONS

All prices are NET and subject to change without notice.

TERMS: **NET 30 DAYS** with approved credit.
All other orders are credit card or COD.
Major credit cards accepted.



Minimum order \$25.00 (\$50.00 International)
All payments made in U.S. dollars.
Drop shipments incur \$2 service charge

FREIGHT: FOB Hicksville, NY

RETURNS: No returns accepted without prior permission.
All authorized returns subject to restocking charge.

© Copyright 2000. All rights reserved. No part of this catalog may be reproduced in any form or any means including photocopying or used by any information storage or retrieval system without written authorization from Tamperproof Screw Co., Inc.

© Snake Eyes is a registered trademark of Tamperproof Screw Co., Inc.
© Opsit is a registered trademark of Tamperproof Screw Co., Inc.
© Torx is a registered trademark of Camcar Div. of Textron, Inc.
© Tri-Wing is a registered trademark of Phillips Screw Co.



TAMPERPROOF SCREW CO., INC. • FOR ADDITIONAL INFORMATION OR TO ORDER

HOW TO ORDER

Placing your order is easy. When calling or faxing to place an order remember to specify the following:

■ TYPE OF SECURITY SCREW

Example — Spanner, Tri-Wing®, TP3, etc.

■ HEAD STYLE

Example — Pan, Button, Flat, etc.

■ THREAD STYLE

Example — Machine, Self-Drilling or Sheet Metal.

■ SIZE AND LENGTH

Example — 4-40 diameter 1-1/2" length, etc.

■ QUANTITY

Example — 100 minimum per size, etc.

TYPE OF SECURITY SCREW

We now offer eight different styles of tamper-resistant screws:

- SNAKE EYES® SPANNER
- PHILLIPS PIN-HEAD
- ONE-WAY
- OPSIT® REVERSE THREAD
- SOCKET PIN-HEAD
- TORX® SECURITY
- TRI-WING®
- TP3®

Select any style which best serves your needs.

Most Screws are 18-8 Stainless Steel.

Some Flat Head/Oval Head Spanner Machine Screws are available in Brass. Self-drilling Torx® Security are 410 Heat-Treated Stainless Steel. Consult your salesperson.

MATCHING TOOLS

All screws* require special matching tools for easy insertion and removal.

Note: Spanner and Pin-Head Tamper-Resistant Tools are NOT guaranteed against overtorque, misuse, breakage or wear and are not refundable.

*One-Ways are easily installed with a standard screw driver. Removal may be possible with the "Un-Do-It" tools.

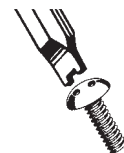

TYPES OF SCREWS

SNAKE EYES® SPANNERS

The original Snake Eyes® Spanner requires matching drive bit reducing the chances of unauthorized removal. Available in 18-8 stainless steel in a wide range of sizes and head styles. Some machine screws available in brass. Nuts are zinc alloy.

PHILLIPS PIN-HEAD

Traditional Phillips drive with tamper-resistant pin added for security. Easy to drive & remove with matching tool. (Cannot be removed with Phillips Screwdriver.) Available in machine & sheet metal screws with flat or pan head design.

ONE-WAY SLOTTED

Popular design installs with standard screwdriver. Reverse side cammed out to prevent unauthorized removal. Machine and sheet metal screws available in round, truss or oval head designs. Sex-bolts also available.

OPSIT® REVERSE THREAD

Opsit® is a reverse thread sheet metal screw that installs counter-clockwise, thus, tightens if removal is attempted. Available with a low profile truss head and Tri-Wing® drive.

SOCKET PIN-HEAD

Engineered for a high degree of tamper-resistance offering positive engaging, high torque transmission while resisting cam-out and tool wear. Available in button & flat head design or set screws (special order). Matching drive bit required for installation and removal.

TORX® PIN-HEAD

Maximum torque transfer & positive tool engagement means easier drive installation with less pressure & slippage. Torx® Pin-Head offers a high degree of security & requires matching drive bit. Available in Button & Flat-Head machine screws & Button, Flat & Pan-head design sheet metal screws.

TRI-WING®

Economical Tri-Wing® tamper-resistant screws are the common choice for high volume assembly operations while offering a minimal degree of security. Machine & sheet metal screws are offered in a Pan-Head design and Opsit® reverse thread.

TP3 TRIANGULAR

New trilobular drive offers a high degree of security requiring matching tool bit.

HEAD STYLES

 **P A N**
Features a low profile, large diameter head with a high-edged crown for increased strength.

 **F L A T**
Installs flush with countersunk materials for clean appearance.

 **T R U S S**
Low profile offers added security. Large diameter head for increased fastening strength.

 **R O U N D**
One-Way screws only. Features a high crown with a deep recess & smaller diameter head than our Truss or Pan Head designs.

 **O V A L**
Used where countersink installation is desired. Rounded head offers deep recess & is visible just above the surface.

 **B U T T O N**
Also used for general purposes with a lower crown & shallower recess than our Round Head design.

THREAD STYLES

 **S H E E T M E T A L A O R A B**
Thread forming screw with locating point.

 **M A C H I N E M S**
Machine screw standard thread, straight sheared point.

 **S E L F D R I L L I N G**
Type AB thread with a 410 heat treated stainless steel, #2 self-drilling point.



SNAKE EYES®



PAN HEAD/MACHINE SCREWS

1 8 - 8 STAINLESS STEEL

DIAMETER	LENGTH	PART NO.	PRICE	DRIVER SIZE
4-40	1/4	1.44014PS	\$24.00	4
	3/8	1.44038PS	\$24.00	
	1/2	1.44012PS	\$24.00	
	5/8	1.44058PS	\$24.00	
	3/4	1.44034PS	\$24.00	
	1	1.4401PS	\$24.00	
	1-1/4	1.440114PS	\$26.00	
	1-1/2	1.440112PS	\$28.00	

DIAMETER	LENGTH	PART NO.	PRICE	DRIVER SIZE
6-32	1/4	1.63214PS	\$24.00	6
	3/8	1.63238PS	\$24.00	
	1/2	1.63212PS	\$24.00	
	5/8	1.63258PS	\$24.00	
	3/4	1.63234PS	\$24.00	
	1	1.6321PS	\$24.00	
	1-1/4	1.632114PS	\$26.00	
	1-1/2	1.632112PS	\$28.00	
2	1.6322PS	\$30.00		
3	1.6323PS	\$60.00		

DIAMETER	LENGTH	PART NO.	PRICE	DRIVER SIZE
8-32	1/4	1.83214PS	\$26.00	8
	3/8	1.83238PS	\$26.00	
	1/2	1.83212PS	\$26.00	
	5/8	1.83258PS	\$26.00	
	3/4	1.83234PS	\$26.00	
	1	1.8321PS	\$26.00	
	1-1/4	1.832114PS	\$28.00	
	1-1/2	1.832112PS	\$30.00	
	2	1.8322PS	\$36.00	
	2-1/2	1.832212PS	\$44.00	
	3	1.8323PS	\$50.00	
	4	1.8324PS	\$70.00	

DIAMETER	LENGTH	PART NO.	PRICE	DRIVER SIZE
10-32	1/4	1.10314PS	\$28.00	10
	3/8	1.10338PS	\$28.00	
	1/2	1.10312PS	\$28.00	
	5/8	1.10358PS	\$28.00	
	3/4	1.10334PS	\$28.00	
	1	1.1031PS	\$28.00	
	1-1/4	1.103114PS	\$32.00	
	1-1/2	1.103112PS	\$36.00	
	2	1.1032PS	\$44.00	
4	1.1034PS	\$80.00		

DIAMETER	LENGTH	PART NO.	PRICE	DRIVER SIZE
10-24	1/4	1.10214PS	\$28.00	10
	3/8	1.10238PS	\$28.00	
	1/2	1.10212PS	\$28.00	
	5/8	1.10258PS	\$28.00	
	3/4	1.10234PS	\$28.00	
	1	1.1021PS	\$28.00	
	1-1/4	1.102114PS	\$32.00	
	1-1/2	1.102112PS	\$36.00	
	2	1.1022PS	\$44.00	
	3	1.1023PS	\$60.00	
4	1.1024PS	\$80.00		

DIAMETER	LENGTH	PART NO.	PRICE	DRIVER SIZE
12-24	1/4	1.12214PS	\$36.00	12
	1/2	1.12212PS	\$36.00	
	3/4	1.12234PS	\$36.00	
	1	1.1221PS	\$36.00	
	1-1/4	1.122114PS	\$40.00	
	1-1/2	1.122112PS	\$44.00	

DIAMETER	LENGTH	PART NO.	PRICE	DRIVER SIZE
1/4-20	3/8	1.14238PS	\$42.00	1/4
	1/2	1.14212PS	\$42.00	
	5/8	1.14258PS	\$42.00	
	3/4	1.14234PS	\$42.00	
	1	1.1421PS	\$42.00	
	1-1/4	1.142114PS	\$44.00	
	1-1/2	1.142112PS	\$44.00	
	2	1.1422PS	\$50.00	
	2-1/4	1.142214PS	\$60.00	
	2-1/2	1.142212PS	\$70.00	
	3	1.1423PS	\$80.00	
	4	1.1424PS	\$100.00	

DIAMETER	LENGTH	PART NO.	PRICE	DRIVER SIZE
1/4-28	1/2	1.14812PS	\$44.00	1/4
	5/8	1.14858PS	\$44.00	
	3/4	1.14834PS	\$44.00	
	1	1.1481PS	\$44.00	
	1-1/2	1.148112PS	\$48.00	



ALL PRICES PER 100
See page 29 for matching tools.

Manufacturers of Snake Eyes® 

TAMPERPROOF SCREW CO., INC. • FOR ADDITIONAL INFORMATION OR TO ORDER

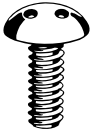

TRUSS HEAD/MACHINE SCREWS

1 8 - 8 STAINLESS STEEL

DIAMETER	LENGTH	PART NO.	PRICE	DRIVER SIZE
6-32	3/8	1.63238TS	\$24.00	6
	1/2	1.63212TS	\$24.00	
	3/4	1.63234TS	\$24.00	
	1	1.6321TS	\$24.00	

DIAMETER	LENGTH	PART NO.	PRICE	DRIVER SIZE
8-32	1/2	1.83212TS	\$26.00	8
	5/8	1.83258TS	\$26.00	
	3/4	1.83234TS	\$26.00	
	1	1.8321TS	\$26.00	
	1-1/4	1.832114TS	\$28.00	
	1-1/2	1.832112TS	\$30.00	
	2-1/2	1.832212TS	\$44.00	

DIAMETER	LENGTH	PART NO.	PRICE	DRIVER SIZE
10-32	1/2	1.10312TS	\$28.00	10
	5/8	1.10358TS	\$28.00	
	3/4	1.10334TS	\$28.00	
	1	1.1031TS	\$28.00	
	1-1/2	1.103112TS	\$36.00	

DIAMETER	LENGTH	PART NO.	PRICE	DRIVER SIZE
10-24	1/2	1.10212TS	\$28.00	10
	3/4	1.10234TS	\$28.00	
	1	1.1021TS	\$28.00	
	1-1/2	1.102112TS	\$36.00	
	1-3/4	1.102134TS	\$40.00	

DIAMETER	LENGTH	PART NO.	PRICE	DRIVER SIZE
1/4-20	3/8	1.14238TS	\$42.00	1/4
	1/2	1.14212TS	\$42.00	
	3/4	1.14234TS	\$42.00	
	1	1.1421TS	\$42.00	
	1-1/4	1.142114TS	\$44.00	
	1-1/2	1.142112TS	\$44.00	
	2	1.1422TS	\$50.00	

DIAMETER	LENGTH	PART NO.	PRICE	DRIVER SIZE
5/16-18	3/4	1.51634TS	\$56.00	1/4
	1	1.5161TS	\$60.00	
	1-1/4	1.516114TS	\$70.00	
	1-1/2	1.516112TS	\$80.00	
	2	1.5162TS	\$80.00	
	2-1/2	1.516212TS	\$90.00	
	3	1.5163TS	\$110.00	

DIAMETER	LENGTH	PART NO.	PRICE	DRIVER SIZE
3/8-16	1/2	1.38612TS	\$80.00	1/4
	5/8	1.38658TS	\$80.00	
	3/4	1.38634TS	\$80.00	
	1	1.3861TS	\$90.00	
	1-1/4	1.386114TS	\$90.00	
	1-1/2	1.386112TS	\$100.00	
	2	1.3862TS	\$100.00	
	2-1/2	1.386212TS	\$120.00	
	3	1.3863TS	\$130.00	
	3-1/2	1.386312TS	\$140.00	



FLAT HEAD/MACHINE SCREWS

1 8 - 8 STAINLESS STEEL

DIAMETER	LENGTH	PART NO.	PRICE	DRIVER SIZE
4-40	1/4	1.44014FS	\$24.00	4
	3/8	1.44038FS	\$24.00	
	1/2	1.44012FS	\$24.00	
	1	1.4401FS	\$24.00	
	1-1/2	1.440112FS	\$28.00	

DIAMETER	LENGTH	PART NO.	PRICE	DRIVER SIZE
6-32	3/16 UC	1.632316UFS	\$24.00	6
	1/4 UC	1.63214UFS	\$24.00	
	1/4	1.63214FS	\$24.00	
	3/8	1.63238FS	\$24.00	
	1/2	1.63212FS	\$24.00	
	5/8	1.63258FS	\$24.00	
	3/4	1.63234FS	\$24.00	
	1	1.6321FS	\$24.00	
	1-1/4	1.632114FS	\$26.00	
	1-1/2	1.632112FS	\$28.00	
	2	1.6322FS	\$30.00	
	3	1.6323FS	\$60.00	

Note: "UC" denotes undercut head.

QUANTITY DISCOUNTS ON SPANNER SCREWS

(Per Size) At 1m screws: less 10% • At 5m screws: less 20% • At 10m screws: less 30%



SNAKE EYES®



FLAT HEAD/MACHINE SCREWS (CON'T)

18-8 STAINLESS STEEL

DIAMETER	LENGTH	PART NO.	PRICE	DRIVER SIZE
8-32	1/4 UC	1.83214UFS	\$26.00	8
	5/16 UC	1.832516UFS	\$26.00	
	3/8 UC	1.83238UFS	\$26.00	
	3/8	1.83238FS	\$26.00	
	1/2 UC	1.83212UFS	\$26.00	
	1/2	1.83212FS	\$26.00	
	5/8 UC	1.83258UFS	\$26.00	
	3/4	1.83234FS	\$26.00	
	1	1.8321FS	\$26.00	
	1-1/4	1.832114FS	\$28.00	
	1-1/2	1.832112FS	\$30.00	
	1-3/4	1.832134FS	\$32.00	
	2	1.8322FS	\$36.00	
	2-1/2	1.832212FS	\$44.00	
	3	1.8323FS	\$50.00	
	4	1.8324FS	\$70.00	

DIAMETER	LENGTH	PART NO.	PRICE	DRIVER SIZE
10-32	3/8 UC	1.10338UFS	\$28.00	10
	1/2 UC	1.10312UFS	\$28.00	
	1/2	1.10312FS	\$28.00	
	5/8	1.10358FS	\$28.00	
	3/4	1.10334FS	\$28.00	
	1	1.1031FS	\$28.00	
	1-1/4	1.103114FS	\$32.00	
	1-1/2	1.103112FS	\$36.00	
	2	1.1032FS	\$44.00	
	3	1.1033FS	\$60.00	
4	1.1034FS	\$80.00		

DIAMETER	LENGTH	PART NO.	PRICE	DRIVER SIZE
10-24	5/16 UC	1.102516UFS	\$28.00	10
	3/8 UC	1.10238UFS	\$28.00	
	3/8	1.10238FS	\$28.00	
	1/2 UC	1.10212UFS	\$28.00	
	1/2	1.10212FS	\$28.00	
	5/8	1.10258FS	\$28.00	
	3/4	1.10234FS	\$28.00	
	1	1.1021FS	\$28.00	
	1-1/4	1.102114FS	\$32.00	
	1-1/2	1.102112FS	\$36.00	
	2	1.1022FS	\$44.00	
	2-1/2	1.102212FS	\$50.00	
	3	1.1023FS	\$60.00	
	4	1.1024FS	\$80.00	

DIAMETER	LENGTH	PART NO.	PRICE	DRIVER SIZE
12-24	1/2 UC	1.12212UFS	\$36.00	12
	3/4	1.12234FS	\$36.00	
	1	1.1221FS	\$36.00	
	1-1/2	1.122112FS	\$44.00	
	2	1.1222FS	\$50.00	

DIAMETER	LENGTH	PART NO.	PRICE	DRIVER SIZE
1/4-20	3/8 UC	1.14238UFS	\$42.00	1/4
	1/2 UC	1.14212UFS	\$42.00	
	1/2	1.14212FS	\$42.00	
	5/8	1.14258FS	\$42.00	
	3/4	1.14234FS	\$42.00	
	7/8	1.14278FS	\$42.00	
	1	1.1421FS	\$42.00	
	1-1/4	1.142114FS	\$44.00	
	1-1/2	1.142112FS	\$44.00	
	2	1.1422FS	\$50.00	
	2-1/4	1.142214FS	\$60.00	
	2-1/2	1.142212FS	\$70.00	
	3	1.1423FS	\$80.00	
4	1.1424FS	\$100.00		

DIAMETER	LENGTH	PART NO.	PRICE	DRIVER SIZE
1/4-28	1/2	1.14812FS	\$44.00	1/4
	3/4	1.14834FS	\$44.00	
	1	1.1481FS	\$44.00	
	1-1/2	1.148112FS	\$48.00	

DIAMETER	LENGTH	PART NO.	PRICE	DRIVER SIZE
5/16-18	3/4	1.51634FS	\$56.00	1/4
	1	1.5161FS	\$60.00	
	1-1/2	1.516112FS	\$80.00	
	2	1.5162FS	\$80.00	
	2-1/2	1.516212FS	\$90.00	
3	1.5163FS	\$110.00		

DIAMETER	LENGTH	PART NO.	PRICE	DRIVER SIZE
3/8-16	1/2 UC	1.38612UFS	\$90.00	1/4
	3/4	1.38634FS	\$80.00	
	1 UC	1.3861UFS	\$90.00	
	1	1.3861FS	\$90.00	
	1-1/2	1.386112FS	\$100.00	
	2	1.3862FS	\$100.00	
	2-1/2	1.386212FS	\$120.00	
	3	1.3863FS	\$130.00	

Note: "UC" denotes undercut head.



ALL PRICES PER 100
See page 29 for matching tools.

Manufacturers of Snake Eyes®

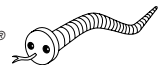

TAMPERPROOF SCREW CO., INC. • FOR ADDITIONAL INFORMATION OR TO ORDER



FLAT HEAD/MACHINE SCREWS

BRASS

DIAMETER	LENGTH	PART NO.	PRICE	DRIVER SIZE
6-32	3/16 UC	1.632316UFB	\$28.00	6
	3/8	1.63238FB	\$28.00	
	1/2	1.63212FB	\$28.00	
	3/4	1.63234FB	\$28.00	
	1	1.6321FB	\$28.00	

DIAMETER	LENGTH	PART NO.	PRICE	DRIVER SIZE
8-32	1/4 UC	1.83214UFB	\$30.00	8
	5/16 UC	1.832516UFB	\$30.00	
	1/2	1.83212FB	\$30.00	
	3/4	1.83234FB	\$30.00	
	1	1.8321FB	\$30.00	
1-1/2	1.832112FB	\$32.00		

DIAMETER	LENGTH	PART NO.	PRICE	DRIVER SIZE
10-24	3/8	1.10238FB	\$32.00	10
	1/2	1.10212FB	\$32.00	
	3/4	1.10234FB	\$32.00	
	1	1.1021FB	\$32.00	
	1-1/2	1.102112FB	\$36.00	
2	1.1022FB	\$40.00		

DIAMETER	LENGTH	PART NO.	PRICE	DRIVER SIZE
12-24	1/2 UC*	1.12212UFC	\$40.00	12

DIAMETER	LENGTH	PART NO.	PRICE	DRIVER SIZE
1/4-20	1/2	1.14212FB	\$44.00	1/4
	3/4	1.14234FB	\$44.00	
	1	1.1421FB	\$44.00	
	1-1/4	1.142114FB	\$50.00	
	1-1/2	1.142112FB	\$50.00	

*Note: Available in Silicon Bronze only.

Note: "UC" denotes undercut head.



Standard Flat Head



Undercut Flat Head



OVAL HEAD/MACHINE SCREWS

18-8 STAINLESS STEEL

DIAMETER	LENGTH	PART NO.	PRICE	DRIVER SIZE
6-32	1/4 UC	1.63214UOS	\$26.00	6
	5/16 UC	1.632516UOS	\$26.00	
	3/8 UC	1.63238UOS	\$26.00	
	3/8	1.63238OS	\$26.00	
	1/2	1.63212OS	\$26.00	
	5/8	1.63258OS	\$26.00	
	3/4	1.63234OS	\$26.00	
	1	1.6321OS	\$26.00	
	1-1/4	1.632114OS	\$28.00	
	1-1/2	1.632112OS	\$30.00	
2	1.6322OS	\$36.00		

DIAMETER	LENGTH	PART NO.	PRICE	DRIVER SIZE
8-32	1/2	1.83212OS	\$28.00	8
	3/4	1.83234OS	\$28.00	
	1	1.8321OS	\$28.00	
	1-1/4	1.832114OS	\$30.00	
	1-3/8	1.832138OS	\$32.00	
	1-1/2	1.832112OS	\$32.00	
	2	1.8322OS	\$40.00	
	2-1/2	1.832212OS	\$50.00	

DIAMETER	LENGTH	PART NO.	PRICE	DRIVER SIZE
10-32	1/2	1.10312OS	\$30.00	10
	5/8	1.10358OS	\$30.00	
	3/4	1.10334OS	\$30.00	
	1	1.1031OS	\$30.00	
	1-1/4	1.103114OS	\$32.00	
	1-1/2	1.103112OS	\$36.00	
	2	1.1032OS	\$48.00	

DIAMETER	LENGTH	PART NO.	PRICE	DRIVER SIZE
10-24	3/8	1.10238OS	\$30.00	10
	1/2	1.10212OS	\$30.00	
	5/8	1.10258OS	\$30.00	
	3/4	1.10234OS	\$30.00	
	1	1.1021OS	\$30.00	
	1-1/4	1.102114OS	\$32.00	
	1-1/2	1.102112OS	\$36.00	
	2	1.1022OS	\$48.00	

DIAMETER	LENGTH	PART NO.	PRICE	DRIVER SIZE
1/4-20	1	1.1421OS	\$44.00	1/4
	1-1/2	1.142112OS	\$48.00	
	2	1.1422OS	\$52.00	

QUANTITY DISCOUNTS ON SPANNER SCREWS

(Per Size) At 1m screws: less 10% • At 5m screws: less 20% • At 10m screws: less 30%



SNAKE EYES®

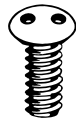

OVAL HEAD/MACHINE SCREWS

BRASS

DIAMETER	LENGTH	PART NO.	PRICE	DRIVER SIZE
6-32	3/8	1.63238OB	\$30.00	6
	1/2	1.63212OB	\$30.00	
	3/4	1.63234OB	\$30.00	
	1	1.63210B	\$30.00	

DIAMETER	LENGTH	PART NO.	PRICE	DRIVER SIZE
8-32	1/2	1.83212OB	\$32.00	8
	3/4	1.83234OB	\$32.00	
	1	1.83210B	\$32.00	
	1-1/4	1.832114OB	\$36.00	
	1-1/2	1.832112OB	\$36.00	
	2	1.83220B	\$40.00	

DIAMETER	LENGTH	PART NO.	PRICE	DRIVER SIZE
10-32	1/2	1.10312OB	\$36.00	10
	5/8	1.10358OB	\$36.00	
	3/4	1.10334OB	\$36.00	
	1	1.10310B	\$36.00	
	1-1/4	1.103114OB	\$40.00	
	1-1/2	1.103112OB	\$40.00	
	2	1.10320B	\$50.00	

DIAMETER	LENGTH	PART NO.	PRICE	DRIVER SIZE
10-24	3/8	1.10238OB	\$36.00	10
	1/2	1.10212OB	\$36.00	
	3/4	1.10234OB	\$36.00	
	1	1.10210B	\$40.00	
	1-1/2	1.102112OB	\$50.00	
	2	1.10220B	\$50.00	



TRUSS HEAD/ SHEET METAL SCREWS

TYPE A, 18-8 STAINLESS STEEL

DIAMETER	LENGTH	PART NO.	PRICE	DRIVER SIZE
#8	1/2	1.8A12TS	\$26.00	8
	3/4	1.8A34TS	\$26.00	
	1	1.8A1TS	\$26.00	
	1-1/4	1.8A114TS	\$28.00	
	1-1/2	1.8A112TS	\$30.00	

DIAMETER	LENGTH	PART NO.	PRICE	DRIVER SIZE
#10	3/8*	1.10AB38TS	\$28.00	10
	1/2	1.10A12TS	\$28.00	
	3/4	1.10A34TS	\$28.00	
	1	1.10A1TS	\$28.00	
	1-1/4	1.10A114TS	\$32.00	
	1-1/2	1.10A112TS	\$36.00	
	2	1.10A2TS	\$40.00	

*Note: Sheet Metal Screws Type AB.



ALL PRICES PER 100
See page 29 for matching tools.

TAMPERPROOF SCREW CO., INC. • FOR ADDITIONAL INFORMATION OR TO ORDER

Manufacturers of Snake Eyes® 



PAN HEAD/SHEET METAL SCREWS

TYPE A, 18-8 STAINLESS STEEL

DIAMETER	LENGTH	PART NO.	PRICE	DRIVER SIZE
#4	1/4	1.4A14PS	\$24.00	4
	3/8	1.4A38PS	\$24.00	
	1/2	1.4A12PS	\$24.00	
	3/4	1.4A34PS	\$24.00	
	1	1.4A1PS	\$24.00	

DIAMETER	LENGTH	PART NO.	PRICE	DRIVER SIZE
#6	1/4*	1.6AB14PS	\$24.00	6
	3/8	1.6A38PS	\$24.00	
	1/2	1.6A12PS	\$24.00	
	5/8	1.6A58PS	\$24.00	
	3/4	1.6A34PS	\$24.00	
	1	1.6A1PS	\$24.00	
	1-1/4	1.6A114PS	\$26.00	
	1-1/2	1.6A112PS	\$28.00	
2	1.6A2PS	\$30.00		

DIAMETER	LENGTH	PART NO.	PRICE	DRIVER SIZE
#8	3/8*	1.8AB38PS	\$26.00	8
	1/2	1.8A12PS	\$26.00	
	5/8	1.8A58PS	\$26.00	
	3/4	1.8A34PS	\$26.00	
	1	1.8A1PS	\$26.00	
	1-1/4	1.8A114PS	\$28.00	
	1-1/2	1.8A112PS	\$30.00	
	1-3/4	1.8A134PS	\$32.00	
	2	1.8A2PS	\$36.00	

DIAMETER	LENGTH	PART NO.	PRICE	DRIVER SIZE
#10	3/8*	1.10AB38PS	\$28.00	10
	1/2	1.10A12PS	\$28.00	
	5/8	1.10A58PS	\$28.00	
	3/4	1.10A34PS	\$28.00	
	1	1.10A1PS	\$28.00	
	1-1/4	1.10A114PS	\$32.00	
	1-1/2	1.10A112PS	\$36.00	
	1-3/4	1.10A134PS	\$40.00	
2	1.10A2PS	\$40.00		

*Note: Sheet Metal Screws Type AB.

DIAMETER	LENGTH	PART NO.	PRICE	DRIVER SIZE
#12	1/2	1.12A12PS	\$36.00	12
	3/4	1.12A34PS	\$36.00	
	1	1.12A1PS	\$36.00	
	1-1/4	1.12A114PS	\$40.00	
	1-1/2	1.12A112PS	\$40.00	
	2	1.12A2PS	\$50.00	

DIAMETER	LENGTH	PART NO.	PRICE	DRIVER SIZE
#14	1/2*	1.14AB12PS	\$42.00	1/4
	3/4	1.14A34PS	\$42.00	
	1	1.14A1PS	\$44.00	
	1-1/4	1.14A114PS	\$46.00	
	1-1/2	1.14A112PS	\$48.00	
	2	1.14A2PS	\$50.00	



FLAT HEAD/SHEET METAL SCREWS

TYPE A, 18-8 STAINLESS STEEL

DIAMETER	LENGTH	PART NO.	PRICE	DRIVER SIZE
#4	1/4 UC*	1.4AB14UFS	\$24.00	4
	3/8	1.4A38FS	\$24.00	
	1/2	1.4A12FS	\$24.00	
	3/4	1.4A34FS	\$24.00	
	1	1.4A1FS	\$24.00	

DIAMETER	LENGTH	PART NO.	PRICE	DRIVER SIZE
#6	3/8*	1.6AB38FS	\$24.00	6
	1/2	1.6A12FS	\$24.00	
	5/8	1.6A58FS	\$24.00	
	3/4	1.6A34FS	\$24.00	
	1	1.6A1FS	\$24.00	
	1-1/4	1.6A114FS	\$26.00	
	1-1/2	1.6A112FS	\$28.00	
	2	1.6A2FS	\$30.00	

Note: "UC" denotes undercut head.

*Note: Sheet Metal Screws Type AB.

QUANTITY DISCOUNTS ON SPANNER SCREWS

(Per Size) At 1m screws: less 10% • At 5m screws: less 20% • At 10m screws: less 30%



SNAKE EYES®



FLAT HEAD/ SHEET METAL SCREWS (CONT)

TYPE A, 18-8 STAINLESS STEEL

DIAMETER	LENGTH	PART NO.	PRICE	DRIVER SIZE
#8	3/8 UC	1.8A38UFS	\$26.00	8
	1/2	1.8A12FS	\$26.00	
	5/8	1.8A58FS	\$26.00	
	3/4	1.8A34FS	\$26.00	
	1	1.8A1FS	\$26.00	
	1-1/4	1.8A114FS	\$28.00	
	1-1/2	1.8A112FS	\$30.00	
	2	1.8A2FS	\$36.00	

DIAMETER	LENGTH	PART NO.	PRICE	DRIVER SIZE
#10	1/2 UC *	1.10AB12UFS	\$28.00	10
	5/8	1.10A58FS	\$28.00	
	3/4	1.10A34FS	\$28.00	
	1	1.10A1FS	\$28.00	
	1-1/4	1.10A114FS	\$32.00	
	1-1/2	1.10A112FS	\$36.00	
	1-3/4	1.10A134FS	\$40.00	
	2	1.10A2FS	\$40.00	

DIAMETER	LENGTH	PART NO.	PRICE	DRIVER SIZE
#12	1/2 UC	1.12A12UFS	\$36.00	12
	3/4	1.12A34FS	\$36.00	
	1	1.12A1FS	\$36.00	
	1-1/4	1.12A114FS	\$40.00	
	1-1/2	1.12A112FS	\$40.00	
	2	1.12A2FS	\$50.00	

DIAMETER	LENGTH	PART NO.	PRICE	DRIVER SIZE
#14	1/2 UC	1.14A12UFS	\$44.00	14
	3/4	1.14A34FS	\$44.00	
	1	1.14A1FS	\$44.00	
	1-1/4	1.14A114FS	\$46.00	
	1-1/2	1.14A112FS	\$48.00	
	2	1.14A2FS	\$50.00	

*Note: Sheet Metal Screws Type AB.

Note: "UC" denotes undercut head.



OVAL HEAD/SHEET METAL SCREWS

TYPE A, 18-8 STAINLESS STEEL

DIAMETER	LENGTH	PART NO.	PRICE	DRIVER SIZE
#6	1/2	1.6A12OS	\$28.00	6
	5/8 UC	1.6A58UOS	\$28.00	
	3/4	1.6A34OS	\$28.00	
	1	1.6A1OS	\$28.00	
	1-1/4	1.6A114OS	\$30.00	
	1-1/2	1.6A112OS	\$32.00	

DIAMETER	LENGTH	PART NO.	PRICE	DRIVER SIZE
#8	1/2	1.8A12OS	\$30.00	8
	3/4	1.8A34OS	\$30.00	
	1	1.8A1OS	\$30.00	
	1-1/4	1.8A114OS	\$32.00	
	1-1/2	1.8A112OS	\$36.00	
2	1.8A2OS	\$40.00		

DIAMETER	LENGTH	PART NO.	PRICE	DRIVER SIZE
#10	1/2 UC	1.10A12UOS	\$32.00	10
	3/4	1.10A34OS	\$32.00	
	1	1.10A1OS	\$32.00	
	1-1/4	1.10A114OS	\$36.00	
	1-1/2	1.10A112OS	\$40.00	

Note: "UC" denotes undercut head.



ALL PRICES PER 100
See page 29 for matching tools.

Manufacturers of Snake Eyes®

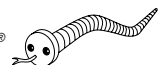

TAMPERPROOF SCREW CO., INC. • FOR ADDITIONAL INFORMATION OR TO ORDER

NUTS

SPANNER NUTS/REMOVABLE

ZINC ALLOY (NON-FERROUS RUST RESISTANT)

DIAMETER	PART NO.	PRICE	DRIVER SIZE
1/4-20	IN.142	\$90.00	1ND
5/16-18	IN.516	\$90.00	
3/8-16	IN.386	\$90.00	
M6	IN.M6	\$90.00	
M8	IN.M8	\$90.00	
M10	IN.M10	\$90.00	

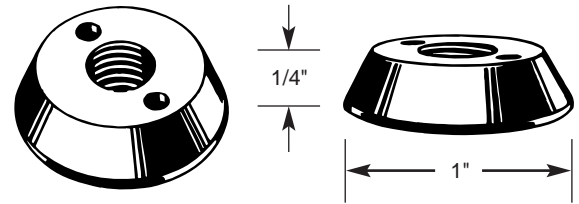

Spanner Nuts

SPANNER NUT BIT

SIZE	PART NO.	PRICE
Bit Only (1/4" Hex)	1NB.14	\$8.00 ea.
Bit Only (5/16" Hex)	1NB.516	\$8.00 ea.

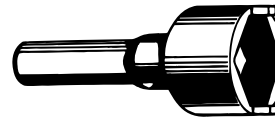

Spanner Nut Bit

SPANNER NUT DRIVER COMPLETE

	PART NO.	PRICE
Driver	1ND	\$16.00 ea.

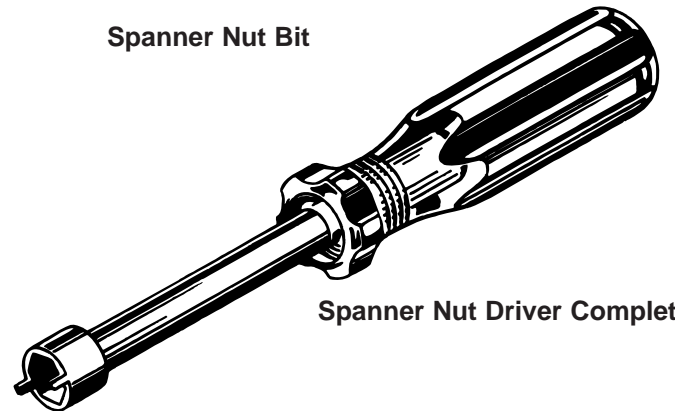

Spanner Nut Driver Complete

BREAKAWAY NUTS/ NON-REMOVABLE

ALUMINUM

DIAMETER	PART NO.	SIZE	PRICE
10-24	BAN.102	7/16" Hex	\$40.00
1/4-20	BAN.142	9/16" Hex	\$52.00
5/16-18	BAN.516	5/8" Hex	\$64.00
3/8-16	BAN.386	3/4" Hex	\$92.00

Note: Uses standard wrench for installation

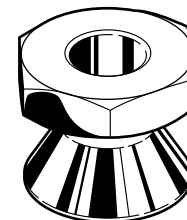

Before

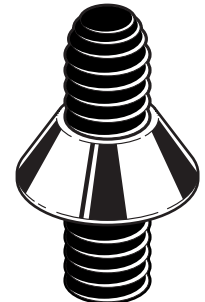

After

Breakaway Nuts

QUANTITY DISCOUNTS ON NUTS AVAILABLE UPON REQUEST.



SOCKET SECURITY

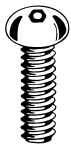

BUTTON HEAD/CAP SCREWS

1 8 - 8 S T A I N L E S S S T E E L

DIAMETER	LENGTH	PART NO.	PRICE	DRIVER SIZE
6-32	1/4	6.63214BS	\$48.00	1/8"
	3/8	6.63238BS	\$40.00	
	1/2	6.63212BS	\$40.00	
	3/4	6.63234BS	\$40.00	
	1	6.6321BS	\$40.00	

DIAMETER	LENGTH	PART NO.	PRICE	DRIVER SIZE
8-32	3/8	6.83238BS	\$36.00	1/8"
	1/2	6.83212BS	\$36.00	
	3/4	6.83234BS	\$36.00	
	1	6.8321BS	\$36.00	
	1-1/2	6.832112BS	\$72.00	

DIAMETER	LENGTH	PART NO.	PRICE	DRIVER SIZE
10-32	1/4	6.10314BS	\$36.00	5/32"
	3/8	6.10338BS	\$36.00	
	1/2	6.10312BS	\$36.00	
	5/8	6.10358BS	\$36.00	
	3/4	6.10334BS	\$36.00	
	1	6.1031BS	\$36.00	
	1-1/4	6.103114BS	\$70.00	
	1-1/2	6.103112BS	\$70.00	
	2	6.1032BS	\$100.00	

DIAMETER	LENGTH	PART NO.	PRICE	DRIVER SIZE
10-24	1/4	6.10214BS	\$40.00	5/32"
	3/8	6.10238BS	\$36.00	
	1/2	6.10212BS	\$36.00	
	3/4	6.10234BS	\$36.00	
	1	6.1021BS	\$36.00	
	1-1/2	6.102112BS	\$70.00	

DIAMETER	LENGTH	PART NO.	PRICE	DRIVER SIZE
1/4-20	1/2	6.14212BS	\$50.00	5/32"
	5/8	6.14258BS	\$50.00	
	3/4	6.14234BS	\$50.00	
	1	6.1421BS	\$60.00	
	1-1/4	6.142114BS	\$60.00	
	1-1/2	6.142112BS	\$70.00	
2	6.1422BS	\$100.00		

DIAMETER	LENGTH	PART NO.	PRICE	DRIVER SIZE
1/4-28	1/2	6.14812BS	\$70.00	5/32"
	3/4	6.14834BS	\$70.00	
	1	6.1481BS	\$70.00	

DIAMETER	LENGTH	PART NO.	PRICE	DRIVER SIZE
5/16-18	3/8	6.51638BS	\$100.00	3/16"
	1/2	6.51612BS	\$100.00	
	3/4	6.51634BS	\$100.00	
	1	6.5161BS	\$100.00	
	1-1/4	6.516114BS	\$120.00	
	1-1/2	6.516112BS	\$120.00	
	2	6.5162BS	\$120.00	

DIAMETER	LENGTH	PART NO.	PRICE	DRIVER SIZE
3/8-16	1/2	6.38612BS	\$160.00	7/32"
	3/4	6.38634BS	\$160.00	
	1	6.3861BS	\$160.00	
	1-1/4	6.386114BS	\$160.00	
	1-1/2	6.386112BS	\$160.00	
	2	6.3862BS	\$180.00	

DIAMETER	LENGTH	PART NO.	PRICE	DRIVER SIZE
1/2-13	1	6.1231BS	\$360.00	5/16"
	1-1/2	6.123112BS	\$400.00	
	2	6.1232BS	\$420.00	
	2-1/2	6.123212BS	\$420.00	
	3	6.1233BS	\$440.00	
	3-1/2	6.123312BS	\$480.00	



SET SCREWS

Special order only. Consult your salesperson.



ALL PRICES PER 100

See pages 30 and 31 for matching tools.

TAMPERPROOF SCREW CO., INC. • FOR ADDITIONAL INFORMATION OR TO ORDER

SOCKET SECURITY



FLAT HEAD/CAP SCREWS

1 8 - 8 STAINLESS STEEL

DIAMETER	LENGTH	PART NO.	PRICE	DRIVER SIZE
6-32	3/8	6.63238FS	\$40.00	1/8"
	1/2	6.63212FS	\$40.00	
	3/4	6.63234FS	\$40.00	
	1	6.6321FS	\$40.00	

DIAMETER	LENGTH	PART NO.	PRICE	DRIVER SIZE
8-32	3/8	6.83238FS	\$36.00	1/8"
	1/2	6.83212FS	\$36.00	
	3/4	6.83234FS	\$36.00	
	1	6.8321FS	\$36.00	

DIAMETER	LENGTH	PART NO.	PRICE	DRIVER SIZE
10-32	1/2	6.10312FS	\$50.00	5/32"
	3/4	6.10334FS	\$50.00	
	1	6.1031FS	\$50.00	
	1-1/2	6.103112FS	\$100.00	1/8"

DIAMETER	LENGTH	PART NO.	PRICE	DRIVER SIZE
10-24	3/8	6.10238FS	\$50.00	5/32"
	1/2	6.10212FS	\$50.00	
	3/4	6.10234FS	\$50.00	
	1	6.1021FS	\$50.00	
	1-1/2	6.102112FS	\$100.00	1/8"

DIAMETER	LENGTH	PART NO.	PRICE	DRIVER SIZE
12-24	1/2 uc	6.12212UFS	\$50.00	5/32"

DIAMETER	LENGTH	PART NO.	PRICE	DRIVER SIZE
1/4-20	1/2	6.14212FS	\$60.00	5/32"
	3/4	6.14234FS	\$60.00	
	1	6.1421FS	\$70.00	
	1-1/4	6.142114FS	\$70.00	
	1-1/2	6.142112FS	\$70.00	
	2	6.1422FS	\$120.00	

DIAMETER	LENGTH	PART NO.	PRICE	DRIVER SIZE
5/16-18	1/2	6.51612FS	\$140.00	3/16"
	3/4	6.51634FS	\$140.00	
	1	6.5161FS	\$140.00	
	1-1/4	6.516114FS	\$140.00	
	1-1/2	6.516112FS	\$140.00	
	2	6.5162FS	\$140.00	

DIAMETER	LENGTH	PART NO.	PRICE	DRIVER SIZE
3/8-16	1/2	6.38612FS	\$160.00	7/32"
	3/4	6.38634FS	\$160.00	
	1	6.3861FS	\$160.00	
	1-1/4	6.386114FS	\$160.00	
	1-1/2	6.386112FS	\$160.00	
	2	6.3862FS	\$180.00	

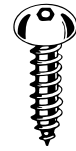

BUTTON HEAD/ SHEET METAL SCREWS

TYPE AB, 1 8 - 8 STAINLESS STEEL

DIAMETER	LENGTH	PART NO.	PRICE	DRIVER SIZE
#8	1/2	6.8AB12BS	\$44.00	1/8"
	3/4	6.8AB34BS	\$44.00	
	1	6.8AB1BS	\$44.00	

DIAMETER	LENGTH	PART NO.	PRICE	DRIVER SIZE
#10	1/2	6.10AB12BS	\$44.00	5/32"
	3/4	6.10AB34BS	\$44.00	
	1	6.10AB1BS	\$44.00	
	1-1/2	6.10AB112BS	\$90.00	

QUANTITY DISCOUNTS ON SOCKET SECURITY SCREWS

(Per Size) At 1m screws: less 10% • At 5m screws: less 20% • At 10m screws: less 30% • At 15m screws: Call for quote.

CALL 516-931-1616 OR FAX 516-931-1654 • WWW.TAMPERPROOF.COM



TORX® SECURITY

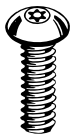

BUTTON HEAD/MACHINE SCREW

18-8 STAINLESS STEEL

DIAMETER	LENGTH	PART NO.	PRICE	DRIVER SIZE
4-40	1/4	4.44014BS	\$26.00	T-8
	3/8	4.44038BS	\$26.00	
	1/2	4.44012BS	\$26.00	
	3/4	4.44034BS	\$26.00	

DIAMETER	LENGTH	PART NO.	PRICE	DRIVER SIZE
6-32	1/4	4.63214BS	\$24.00	T-10
	3/8	4.63238BS	\$24.00	
	1/2	4.63212BS	\$24.00	
	3/4	4.63234BS	\$24.00	
	1	4.6321BS	\$24.00	
	1-1/4	4.632114BS	\$50.00	
	1-1/2	4.632112BS	\$50.00	

DIAMETER	LENGTH	PART NO.	PRICE	DRIVER SIZE
8-32	1/4	4.83214BS	\$24.00	T-15
	3/8	4.83238BS	\$26.00	
	1/2	4.83212BS	\$28.00	
	3/4	4.83234BS	\$30.00	
	1	4.8321BS	\$32.00	
	1-1/4	4.832114BS	\$60.00	
	1-1/2	4.832112BS	\$60.00	

DIAMETER	LENGTH	PART NO.	PRICE	DRIVER SIZE
10-32	3/8	4.10338BS	\$40.00	T-25
	1/2	4.10312BS	\$40.00	
	5/8	4.10358BS	\$40.00	
	3/4	4.10334BS	\$40.00	
	1	4.1031BS	\$40.00	
	1-1/4	4.103114BS	\$50.00	

DIAMETER	LENGTH	PART NO.	PRICE	DRIVER SIZE
10-24	3/8	4.10238BS	\$36.00	T-25
	1/2	4.10212BS	\$40.00	
	5/8	4.10258BS	\$40.00	
	3/4	4.10234BS	\$40.00	
	1	4.1021BS	\$40.00	
	1-1/4	4.102114BS	\$50.00	

DIAMETER	LENGTH	PART NO.	PRICE	DRIVER SIZE
1/4-20	1/2	4.14212BS	\$50.00	T-27
	3/4	4.14234BS	\$50.00	
	1	4.1421BS	\$60.00	
	1-1/4	4.142114BS	\$70.00	
	1-1/2	4.142112BS	\$70.00	
	2	4.1422BS	\$100.00	

DIAMETER	LENGTH	PART NO.	PRICE	DRIVER SIZE
1/4-28	1/2	4.14812BS	\$60.00	T-27
	3/4	4.14834BS	\$60.00	
	1	4.1481BS	\$70.00	

DIAMETER	LENGTH	PART NO.	PRICE	DRIVER SIZE
5/16-18	3/4	4.51634BS	\$80.00	T-40
	1	4.5161BS	\$90.00	
	1-1/2	4.516112BS	\$110.00	



BUTTON HEAD/SHEET METAL SCREWS

TYPE A, 18-8 STAINLESS STEEL

DIAMETER	LENGTH	PART NO.	PRICE	DRIVER SIZE
#6	1/2	4.6A12BS	\$26.00	T-10
	3/4	4.6A34BS	\$26.00	
	1	4.6A1BS	\$26.00	

DIAMETER	LENGTH	PART NO.	PRICE	DRIVER SIZE
#8	1/2	4.8A12BS	\$34.00	T-15
	3/4	4.8A34BS	\$34.00	
	1	4.8A1BS	\$34.00	
	1-1/4	4.8A114BS	\$44.00	
	1-1/2	4.8A112BS	\$50.00	

DIAMETER	LENGTH	PART NO.	PRICE	DRIVER SIZE
#10	1/2	4.10A12BS	\$36.00	T-25
	3/4	4.10A34BS	\$36.00	
	1	4.10A1BS	\$36.00	
	1-1/4	4.10A114BS	\$48.00	
	1-1/2	4.10A112BS	\$50.00	

DIAMETER	LENGTH	PART NO.	PRICE	DRIVER SIZE
#12	2*	4.12AB2BS	\$70.00	T-27
	2-1/2*	4.12AB212BS	\$80.00	
	3*	4.12AB3BS	\$90.00	

DIAMETER	LENGTH	PART NO.	PRICE	DRIVER SIZE
#14	1	4.14A1BS	\$66.00	T-27
	1-1/2	4.14A112BS	\$72.00	

* Sheet metal screws type AB



ALL PRICES PER 100

See pages 32 and 33 for matching tools.

TAMPERPROOF SCREW CO., INC. • FOR ADDITIONAL INFORMATION OR TO ORDER

TORX® SECURITY

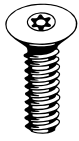

FLAT HEAD/MACHINE SCREW

18-8 STAINLESS STEEL

DIAMETER	LENGTH	PART NO.	PRICE	DRIVER SIZE
4-40	1/4	4.44014FS	\$26.00	T-8
	3/8	4.44038FS	\$26.00	
	1/2	4.44012FS	\$26.00	

DIAMETER	LENGTH	PART NO.	PRICE	DRIVER SIZE
6-32	3/8	4.63238FS	\$24.00	T-10
	1/2	4.63212FS	\$24.00	
	3/4	4.63234FS	\$24.00	
	1	4.6321FS	\$24.00	

DIAMETER	LENGTH	PART NO.	PRICE	DRIVER SIZE
8-32	3/8	4.83238FS	\$26.00	T-15
	1/2	4.83212FS	\$28.00	
	3/4	4.83234FS	\$30.00	
	1	4.8321FS	\$32.00	

DIAMETER	LENGTH	PART NO.	PRICE	DRIVER SIZE
10-32	1/2	4.10312FS	\$40.00	T-20
	3/4	4.10334FS	\$40.00	
	1	4.1031FS	\$44.00	
	1-1/4	4.103114FS	\$50.00	

DIAMETER	LENGTH	PART NO.	PRICE	DRIVER SIZE
10-24	1/2	4.10212FS	\$40.00	T-20
	3/4	4.10234FS	\$40.00	
	1	4.1021FS	\$44.00	
	1-1/4	4.102114FS	\$50.00	

DIAMETER	LENGTH	PART NO.	PRICE	DRIVER SIZE
12-24	1/2 UC	4.12212UFS	\$44.00	

DIAMETER	LENGTH	PART NO.	PRICE	DRIVER SIZE
1/4-20	3/8 UC	4.14238UFS	\$60.00	T-25
	1/2 UC	4.14212UFS	\$50.00	
	1/2	4.14212FS	\$50.00	T-27
	3/4	4.14234FS	\$50.00	
	1	4.1421FS	\$60.00	
	1-1/4	4.142114FS	\$70.00	
1-1/2	4.142112FS	\$70.00		

Note: "UC" denotes undercut head.



FLAT HEAD/SHEET METAL SCREW

TYPE A, 18-8 STAINLESS STEEL

DIAMETER	LENGTH	PART NO.	PRICE	DRIVER SIZE
#6	1/2	4.6A12FS	\$26.00	T-10
	3/4	4.6A34FS	\$26.00	
	1	4.6A1FS	\$26.00	

DIAMETER	LENGTH	PART NO.	PRICE	DRIVER SIZE
#8	1/2	4.8A12FS	\$32.00	T-15
	3/4	4.8A34FS	\$36.00	
	1	4.8A1FS	\$40.00	
	1-1/4	4.8A114FS	\$44.00	

DIAMETER	LENGTH	PART NO.	PRICE	DRIVER SIZE
#10	3/4	4.10A34FS	\$40.00	T-20
	1	4.10A1FS	\$44.00	
	1-1/4	4.10A114FS	\$50.00	
	1-1/2	4.10A112FS	\$50.00	

DIAMETER	LENGTH	PART NO.	PRICE	DRIVER SIZE
#12	2*	4.12AB2FS	\$70.00	T-25
	2-1/2*	4.12AB212FS	\$80.00	
	3*	4.12AB3FS	\$90.00	

DIAMETER	LENGTH	PART NO.	PRICE	DRIVER SIZE
#14	1	4.14A1FS	\$66.00	T-30
	1-1/2	4.14A112FS	\$72.00	

* Sheet metal screws type AB



SIX-LOBE SECURITY PAN HEAD SELF-DRILLING SHEET METAL SCREWS

TYPE AB, 410 STAINLESS STEEL

DIAMETER	LENGTH	PART NO.	PRICE	DRIVER SIZE
#8	1/2	4.8ABK12PS	\$36.00	T-20
	3/4	4.8ABK34PS	\$36.00	
	1	4.8ABK1PS	\$40.00	
	1-1/4	4.8ABK114PS	\$50.00	

DIAMETER	LENGTH	PART NO.	PRICE	DRIVER SIZE
#10	1/2	4.10ABK12PS	\$38.00	T-25
	3/4	4.10ABK34PS	\$38.00	
	1	4.10ABK1PS	\$40.00	
	1-1/4	4.10ABK114PS	\$50.00	
	1-1/2	4.10ABK112PS	\$56.00	

QUANTITY DISCOUNTS ON TORX® SECURITY SCREWS

(Per Size) At 1m screws: less 10% • At 5m screws: less 20% • At 10m screws: less 30% • At 25m screws: Call for quote. Note: Discount schedule doesn't apply to #12 SMS.

CALL 516-931-1616 OR FAX 516-931-1654 • WWW.TAMPERPROOF.COM



PHILLIPS® SECURITY



PAN HEAD/MACHINE SCREW

18 - 8 STAINLESS STEEL

DIAMETER	LENGTH	PART NO.	PRICE	DRIVER SIZE
6-32	1/4	2.63214PS	\$50.00	P2
	3/8	2.63238PS	\$50.00	
	1/2	2.63212PS	\$50.00	
	5/8	2.63258PS	\$50.00	
	3/4	2.63234PS	\$50.00	
	1	2.6321PS	\$50.00	
	1-1/4	2.632114PS	\$52.00	
	1-1/2	2.632112PS	\$54.00	
	2	2.6322PS	\$56.00	

DIAMETER	LENGTH	PART NO.	PRICE	DRIVER SIZE
10-24	3/8	2.10238PS	\$50.00	P2
	1/2	2.10212PS	\$50.00	
	3/4	2.10234PS	\$50.00	
	1	2.1021PS	\$50.00	
	1-1/4	2.102114PS	\$52.00	
	1-1/2	2.102112PS	\$56.00	
	2	2.1022PS	\$60.00	
	2-1/2	2.102212PS	\$70.00	
	3	2.1023PS	\$80.00	

DIAMETER	LENGTH	PART NO.	PRICE	DRIVER SIZE
8-32	3/8	2.83238PS	\$50.00	P2
	1/2	2.83212PS	\$50.00	
	5/8	2.83258PS	\$50.00	
	3/4	2.83234PS	\$50.00	
	1	2.8321PS	\$50.00	
	1-1/4	2.832114PS	\$52.00	
	1-1/2	2.832112PS	\$54.00	
	2	2.8322PS	\$56.00	
	2-1/2	2.832212PS	\$70.00	
3	2.8323PS	\$80.00		

DIAMETER	LENGTH	PART NO.	PRICE	DRIVER SIZE
12-24	1/2	2.12212PS	\$52.00	P3
	3/4	2.12234PS	\$52.00	
	1	2.1221PS	\$52.00	
	1-1/2	2.122112PS	\$64.00	

DIAMETER	LENGTH	PART NO.	PRICE	DRIVER SIZE
10-32	1/4	2.10314PS	\$50.00	P2
	3/8	2.10338PS	\$50.00	
	1/2	2.10312PS	\$50.00	
	5/8	2.10358PS	\$50.00	
	3/4	2.10334PS	\$50.00	
	1	2.1031PS	\$50.00	
	1-1/4	2.103114PS	\$52.00	
	1-1/2	2.103112PS	\$56.00	
	2	2.1032PS	\$60.00	
	2-1/2	2.103212PS	\$70.00	
	3	2.1033PS	\$80.00	

DIAMETER	LENGTH	PART NO.	PRICE	DRIVER SIZE
1/4-20	1/2	2.14212PS	\$72.00	P3
	3/4	2.14234PS	\$72.00	
	1	2.1421PS	\$72.00	
	1-1/4	2.142114PS	\$74.00	
	1-1/2	2.142112PS	\$74.00	
	2	2.1422PS	\$80.00	
	2-1/2	2.142212PS	\$90.00	
	3	2.1423PS	\$100.00	
	3-1/2	2.142312PS	\$120.00	

DIAMETER	LENGTH	PART NO.	PRICE	DRIVER SIZE
1/4-28	1/2	2.14812PS	\$72.00	P3
	3/4	2.14834PS	\$72.00	
	1	2.1481PS	\$72.00	



ALL PRICES PER 100
See page 31 for matching tools.

TAMPERPROOF SCREW CO., INC. • FOR ADDITIONAL INFORMATION OR TO ORDER



FLAT HEAD/MACHINE SCREW

1 8 - 8 S T A I N L E S S S T E E L

DIAMETER	LENGTH	PART NO.	PRICE	DRIVER SIZE
6-32	1/4	2.63214FS	\$50.00	P2
	3/8	2.63238FS	\$50.00	
	1/2	2.63212FS	\$50.00	
	3/4	2.63234FS	\$50.00	
	1	2.6321FS	\$52.00	
	1-1/4	2.632114FS	\$52.00	
	1-1/2	2.632112FS	\$54.00	
	2	2.6322FS	\$56.00	

DIAMETER	LENGTH	PART NO.	PRICE	DRIVER SIZE
8-32	3/8	2.83238FS	\$50.00	P2
	1/2	2.83212FS	\$50.00	
	3/4	2.83234FS	\$50.00	
	1	2.8321FS	\$50.00	
	1-1/4	2.832114FS	\$52.00	
	1-1/2	2.832112FS	\$56.00	
	2	2.8322FS	\$60.00	
	2-1/2	2.832212FS	\$70.00	

DIAMETER	LENGTH	PART NO.	PRICE	DRIVER SIZE
10-32	3/8	2.10338FS	\$50.00	P2
	1/2	2.10312FS	\$50.00	
	3/4	2.10334FS	\$50.00	
	1	2.1031FS	\$50.00	
	1-1/4	2.103114FS	\$52.00	
	1-1/2	2.103112FS	\$56.00	
	2	2.1032FS	\$60.00	
	2-1/2	2.103212FS	\$70.00	

DIAMETER	LENGTH	PART NO.	PRICE	DRIVER SIZE
10-24	3/8	2.10238FS	\$50.00	P2
	1/2	2.10212FS	\$50.00	
	3/4	2.10234FS	\$50.00	
	1	2.1021FS	\$50.00	
	1-1/4	2.102114FS	\$52.00	
	1-1/2	2.102112FS	\$56.00	
	2	2.1022FS	\$60.00	
	2-1/2	2.102212FS	\$70.00	
	3	2.1023FS	\$80.00	

DIAMETER	LENGTH	PART NO.	PRICE	DRIVER SIZE
12-24	1/2	2.12212FS	\$52.00	P3
	3/4	2.12234FS	\$52.00	
	1	2.1221FS	\$52.00	
	1-1/4	2.122114FS	\$56.00	
	1-1/2	2.122112FS	\$64.00	

DIAMETER	LENGTH	PART NO.	PRICE	DRIVER SIZE
1/4-20	1/2	2.14212FS	\$72.00	P3
	3/4	2.14234FS	\$72.00	
	1	2.1421FS	\$72.00	
	1-1/4	2.142114FS	\$74.00	
	1-1/2	2.142112FS	\$74.00	
	2	2.1422FS	\$80.00	
	2-1/2	2.142212FS	\$90.00	
	3	2.1423FS	\$100.00	



PHILLIPS® SECURITY



PAN HEAD/SHEET METAL SCREWS

TYPE A, 18-8 STAINLESS STEEL

DIAMETER	LENGTH	PART NO.	PRICE	DRIVER SIZE
#6	1/2	2.6A12PS	\$50.00	P2
	5/8	2.6A58PS	\$50.00	
	3/4	2.6A34PS	\$50.00	
	1	2.6A1PS	\$50.00	
	1-1/4	2.6A114PS	\$52.00	
	1-1/2	2.6A112PS	\$54.00	
	2	2.6A2PS	\$56.00	

DIAMETER	LENGTH	PART NO.	PRICE	DRIVER SIZE
#12	1/2	2.12A12PS	\$52.00	P3
	3/4	2.12A34PS	\$52.00	
	1	2.12A1PS	\$52.00	
	1-1/4	2.12A114PS	\$56.00	
	1-1/2	2.12A112PS	\$64.00	
	2	2.12A2PS	\$64.00	
	2-1/2	2.12A212PS	\$80.00	
3	2.12A3PS	\$80.00		

DIAMETER	LENGTH	PART NO.	PRICE	DRIVER SIZE
#8	3/8	2.8A38PS	\$50.00	P2
	1/2	2.8A12PS	\$50.00	
	3/4	2.8A34PS	\$50.00	
	1	2.8A1PS	\$50.00	
	1-1/4	2.8A114PS	\$52.00	
	1-1/2	2.8A112PS	\$54.00	
	2	2.8A2PS	\$56.00	
	2-1/2	2.8A212PS	\$70.00	
3	2.8A3PS	\$80.00		

DIAMETER	LENGTH	PART NO.	PRICE	DRIVER SIZE
#14	1/2	2.14A12PS	\$72.00	P3
	3/4	2.14A34PS	\$72.00	
	1	2.14A1PS	\$72.00	
	1-1/4	2.14A114PS	\$74.00	
	1-1/2	2.14A112PS	\$74.00	
	2	2.14A2PS	\$80.00	
	2-1/2	2.14A212PS	\$90.00	
	3	2.14A3PS	\$100.00	

DIAMETER	LENGTH	PART NO.	PRICE	DRIVER SIZE
#10	1/2	2.10A12PS	\$50.00	P2
	3/4	2.10A34PS	\$50.00	
	1	2.10A1PS	\$50.00	
	1-1/4	2.10A114PS	\$52.00	
	1-1/2	2.10A112PS	\$54.00	
	2	2.10A2PS	\$60.00	
	2-1/2	2.10A212PS	\$70.00	
	3	2.10A3PS	\$80.00	
	3-1/2	2.10A312PS	\$90.00	



ALL PRICES PER 100
See page 31 for matching tools.

TAMPERPROOF SCREW CO., INC. • FOR ADDITIONAL INFORMATION OR TO ORDER

PHILLIPS® SECURITY



FLAT HEAD/SHEET METAL SCREWS

TYPE A, 18-8 STAINLESS STEEL

DIAMETER	LENGTH	PART NO.	PRICE	DRIVER SIZE
#6	1/2	2.6A12FS	\$50.00	P2
	3/4	2.6A34FS	\$50.00	
	1	2.6A1FS	\$50.00	
	1-1/4	2.6A114FS	\$52.00	
	1-1/2	2.6A112FS	\$54.00	
	2	2.6A2FS	\$56.00	

DIAMETER	LENGTH	PART NO.	PRICE	DRIVER SIZE
#8	1/2	2.8A12FS	\$50.00	P2
	3/4	2.8A34FS	\$50.00	
	1	2.8A1FS	\$50.00	
	1-1/4	2.8A114FS	\$52.00	
	1-1/2	2.8A112FS	\$54.00	
	2	2.8A2FS	\$56.00	
	2-1/2	2.8A212FS	\$70.00	
3	2.8A3FS	\$80.00		

DIAMETER	LENGTH	PART NO.	PRICE	DRIVER SIZE
#10	1/2	2.10A12FS	\$50.00	P2
	3/4	2.10A34FS	\$50.00	
	1	2.10A1FS	\$50.00	
	1-1/4	2.10A114FS	\$52.00	
	1-1/2	2.10A112FS	\$54.00	
	2	2.10A2FS	\$60.00	
	2-1/2	2.10A212FS	\$70.00	
	3	2.10A3FS	\$80.00	

DIAMETER	LENGTH	PART NO.	PRICE	DRIVER SIZE
#12	1/2	2.12A12FS	\$52.00	P3
	3/4	2.12A34FS	\$52.00	
	1	2.12A1FS	\$52.00	
	1-1/4	2.12A114FS	\$56.00	
	1-1/2	2.12A112FS	\$64.00	
	2	2.12A2FS	\$64.00	
	2-1/2	2.12A212FS	\$80.00	
3	2.12A3FS	\$80.00		

DIAMETER	LENGTH	PART NO.	PRICE	DRIVER SIZE
#14	3/4	2.14A34FS	\$72.00	P3
	1	2.14A1FS	\$72.00	
	1-1/4	2.14A114FS	\$74.00	
	1-1/2	2.14A112FS	\$74.00	
	2	2.14A2FS	\$80.00	
	2-1/2	2.14A212FS	\$90.00	
	3	2.14A3FS	\$100.00	



ONE WAY

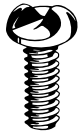

ROUND HEAD/MACHINE SCREWS

1 8 - 8 S T A I N L E S S S T E E L

DIAMETER	LENGTH	PART NO.	PRICE	DRIVER SIZE
4-40	1/4	5.44014RS	\$8.00	No Matching Driver Needed
	5/16	5.440516RS	\$8.00	
	3/8	5.44038RS	\$8.00	
	1/2	5.44012RS	\$8.00	
	3/4	5.44034RS	\$10.00	
	1	5.4401RS	\$12.00	

DIAMETER	LENGTH	PART NO.	PRICE	DRIVER SIZE
6-32	3/16	5.632316RS	\$10.00	No Matching Driver Needed
	1/4	5.63214RS	\$10.00	
	3/8	5.63238RS	\$10.00	
	1/2	5.63212RS	\$10.00	
	3/4	5.63234RS	\$12.00	
	1	5.6321RS	\$14.00	

DIAMETER	LENGTH	PART NO.	PRICE	DRIVER SIZE
8-32	1/4	5.83214RS	\$12.00	No Matching Driver Needed
	3/8	5.83238RS	\$12.00	
	1/2	5.83212RS	\$14.00	
	3/4	5.83234RS	\$14.00	
	1	5.8321RS	\$14.00	
	1-1/4	5.832114RS	\$16.00	
	1-1/2	5.832112RS	\$20.00	

DIAMETER	LENGTH	PART NO.	PRICE	DRIVER SIZE
10-32	3/8	5.10338RS	\$14.00	No Matching Driver Needed
	1/2	5.10312RS	\$14.00	
	5/8	5.10358RS	\$14.00	
	3/4	5.10334RS	\$16.00	
	1	5.1031RS	\$18.00	
	1-1/4	5.103114RS	\$20.00	
	1-1/2	5.103112RS	\$24.00	
	2	5.1032RS	\$30.00	

DIAMETER	LENGTH	PART NO.	PRICE	DRIVER SIZE
10-24	1/4	5.10214RS	\$14.00	No Matching Driver Needed
	3/8	5.10238RS	\$14.00	
	1/2	5.10212RS	\$14.00	
	5/8	5.10258RS	\$14.00	
	3/4	5.10234RS	\$16.00	
	1	5.1021RS	\$18.00	
	1-1/4	5.102114RS	\$20.00	
	1-1/2	5.102112RS	\$24.00	
	2	5.1022RS	\$30.00	

DIAMETER	LENGTH	PART NO.	PRICE	DRIVER SIZE
1/4-20	1/2	5.14212RS	\$26.00	No Matching Driver Needed
	5/8	5.14258RS	\$26.00	
	3/4	5.14234RS	\$30.00	
	7/8	5.14278RS	\$32.00	
	1	5.1421RS	\$36.00	
	1-1/4	5.142114RS	\$40.00	
	1-1/2	5.142112RS	\$40.00	
	2	5.1422RS	\$48.00	

DIAMETER	LENGTH	PART NO.	PRICE	DRIVER SIZE
5/16-18	3/4	5.51634RS	\$44.00	No Matching Driver Needed
	1	5.5161RS	\$50.00	
	1-1/2	5.516112RS	\$60.00	
	2	5.5162RS	\$70.00	

ONE-WAYS are easily installed with a standard screwdriver. Removal may be possible with the "Un-Do-It" removal tools. See tools on page 33.



TRUSS HEAD/MACHINE SCREWS

1 8 - 8 S T A I N L E S S S T E E L

DIAMETER	LENGTH	PART NO.	PRICE	DRIVER SIZE
10-32	1/4	5.10314TS	\$14.00	No Matching Driver Needed
	3/8	5.10338TS	\$16.00	
	1/2	5.10312TS	\$18.00	
	3/4	5.10334TS	\$20.00	

DIAMETER	LENGTH	PART NO.	PRICE	DRIVER SIZE
*10-24	1/2	5.10212TS	\$18.00	No Matching Driver Needed
	3/4	5.10234TS	\$20.00	
	1	5.1021TS	\$24.00	
	1-1/4	5.102114TS	\$26.00	
	1-1/2	5.102112TS	\$28.00	
	2	5.1022TS	\$30.00	

*Note: These screws may be used with the Female One-Way sex bolts. See page 24.



ALL PRICES PER 100

TAMPERPROOF SCREW CO., INC. • FOR ADDITIONAL INFORMATION OR TO ORDER

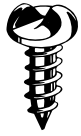

ROUND HEAD/ SHEET METAL SCREWS

TYPE A, 18-8 STAINLESS STEEL

DIAMETER	LENGTH	PART NO.	PRICE	DRIVER SIZE
#4	3/8	5.4A38RS	\$8.00	No Matching Driver Needed
	1/2	5.4A12RS	\$8.00	
	3/4	5.4A34RS	\$10.00	

DIAMETER	LENGTH	PART NO.	PRICE	DRIVER SIZE
#6	1/2	5.6A12RS	\$10.00	No Matching Driver Needed
	3/4	5.6A34RS	\$12.00	
	1	5.6A1RS	\$14.00	
	1-1/4	5.6A114RS	\$16.00	

DIAMETER	LENGTH	PART NO.	PRICE	DRIVER SIZE
#8	1/2	5.8A12RS	\$14.00	No Matching Driver Needed
	3/4	5.8A34RS	\$14.00	
	1	5.8A1RS	\$14.00	
	1-1/4	5.8A114RS	\$16.00	
	1-1/2	5.8A112RS	\$20.00	

DIAMETER	LENGTH	PART NO.	PRICE	DRIVER SIZE
#10	1/2	5.10A12RS	\$14.00	No Matching Driver Needed
	3/4	5.10A34RS	\$16.00	
	1	5.10A1RS	\$18.00	
	1-1/4	5.10A114RS	\$20.00	
	1-1/2	5.10A112RS	\$24.00	
	2	5.10A2RS	\$30.00	

DIAMETER	LENGTH	PART NO.	PRICE	DRIVER SIZE
#12	1/2*	5.12A12PS	\$16.00	No Matching Driver Needed
	5/8*	5.12A58PS	\$16.00	
	3/4*	5.12A34PS	\$18.00	
	1*	5.12A1PS	\$20.00	
	1-1/4*	5.12A114PS	\$24.00	
	1-1/2*	5.12A112PS	\$28.00	
	2*	5.12A2PS	\$36.00	
	2-1/2	5.12A212RS	\$56.00	

DIAMETER	LENGTH	PART NO.	PRICE	DRIVER SIZE
#14	1/2	5.14A12RS	\$26.00	No Matching Driver Needed
	3/4	5.14A34RS	\$30.00	
	1	5.14A1RS	\$36.00	
	1-1/4	5.14A114RS	\$40.00	
	1-1/2	5.14A112RS	\$40.00	
	2	5.14A2RS	\$48.00	
	3	5.14A3RS	\$56.00	

*Available in Pan Head only.



OVAL HEAD/COUNTERSUNK MACHINE SCREWS

18-8 STAINLESS STEEL

DIAMETER	LENGTH	PART NO.	PRICE	DRIVER SIZE
6-32	1/2	5.63212OS	\$10.00	No Matching Driver Needed
	3/4	5.63234OS	\$12.00	
	1	5.6321OS	\$14.00	

DIAMETER	LENGTH	PART NO.	PRICE	DRIVER SIZE
8-32	1/2	5.83212OS	\$12.00	No Matching Driver Needed
	3/4	5.83234OS	\$14.00	
	1	5.8321OS	\$16.00	

DIAMETER	LENGTH	PART NO.	PRICE	DRIVER SIZE
10-32	1/2	5.10312OS	\$14.00	No Matching Driver Needed
	3/4	5.10334OS	\$16.00	
	1	5.1031OS	\$18.00	

DIAMETER	LENGTH	PART NO.	PRICE	DRIVER SIZE
10-24	1/2	5.10212OS	\$14.00	No Matching Driver Needed
	3/4	5.10234OS	\$16.00	
	1	5.1021OS	\$18.00	

DIAMETER	LENGTH	PART NO.	PRICE	DRIVER SIZE
1/4-20	1/2	5.14212OS	\$26.00	No Matching Driver Needed
	1	5.1421OS	\$36.00	
	1-1/2	5.142112OS	\$40.00	

ONE-WAYS are easily installed with a standard screwdriver. Removal may be possible with the "Un-Do-It" removal tools. See tools on page 33.

QUANTITY DISCOUNTS ON ONE-WAY SECURITY SCREWS

(Per Size) At 1m screws: less 10% • At 5m screws: less 20% • At 10m screws: less 30% • At 15m: Call for quote



ONE WAY



OVAL HEAD/COUNTERSUNK SHEET METAL SCREWS

TYPE A, 18-8 STAINLESS STEEL

DIAMETER	LENGTH	PART NO.	PRICE	DRIVER SIZE
#8	1/2	5.8A12OS	\$12.00	No Matching Driver Needed
	3/4	5.8A34OS	\$14.00	
	1	5.8A1OS	\$16.00	
	1-1/4	5.8A114OS	\$18.00	
	1-1/2	5.8A112OS	\$20.00	

DIAMETER	LENGTH	PART NO.	PRICE	DRIVER SIZE
#10	1/2 UC	5.10A12UOS	\$14.00	No Matching Driver Needed
	3/4	5.10A34OS	\$16.00	
	1	5.10A1OS	\$18.00	
	1-1/4	5.10A114OS	\$20.00	
	1-1/2	5.10A112OS	\$24.00	

Note: "UC" denotes undercut head.

ONE WAY SEX BOLT

ONE WAY SEX BOLTS

18-8 STAINLESS STEEL

One Way Sex Bolts are only available as 10-24 Truss Heads in 18-8 Stainless Steel only. They may be ordered as a complete set, consisting of a male and female part, and sized according to the **Total Partition Size**. Posts fit 1/4" diameter holes.

Or, these screws can be ordered **individually** as separate male and female parts.

See accompanying chart for dimension details.

To order by partition size: priced per set.
Each set consisting of 2 screws (1 male, 1 female):

DIAMETER	LENGTH	PART NO.	PRICE	DRIVER SIZE
10-24	3/4	5X.10234PS	\$120.00	No Matching Driver Needed
	1	5X.1021PS	\$130.00	
	1-1/4	5X.102114PS	\$130.00	

To order individual male and female parts:

DIAMETER	LENGTH	PART NO.	PRICE	DRIVER SIZE
10-24	1/2 Male	5X.10212MS	\$60.00	No Matching Driver Needed
	3/4 Male	5X.10234MS	\$70.00	
	1/2 Female	5X.10212FS	\$80.00	
	3/4 Female	5X.10234FS	\$90.00	
	1 Female	5X.1021FS	\$100.00	

DIMENSIONS OF SETS				
M	+	F	=	P
1/2"	+	1/2"	=	3/4"
3/4"	+	3/4"	=	1"
3/4"	+	1"	=	1-1/4"

Note: M denotes male, F denotes female, P denotes partition size.

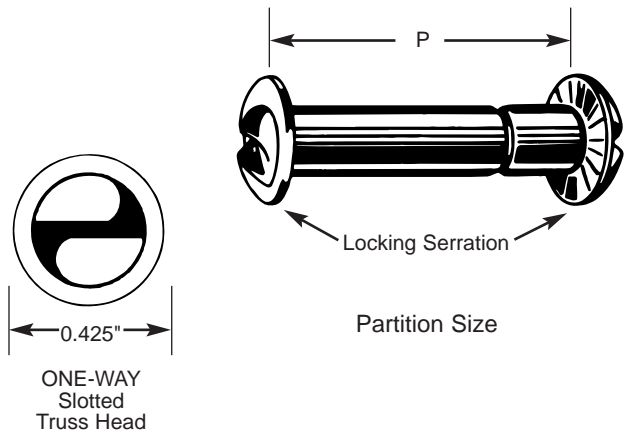
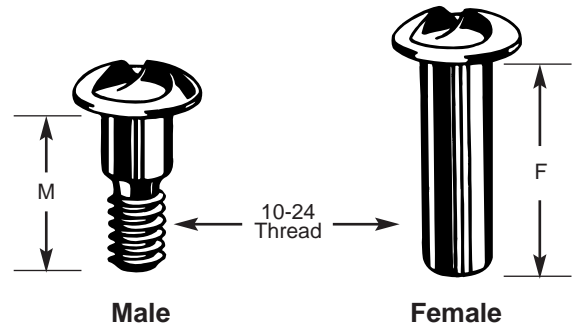

ALL PRICES PER 100
See page 33 for matching tools.

TAMPERPROOF SCREW CO., INC. • FOR ADDITIONAL INFORMATION OR TO ORDER



PAN HEAD/SHEET METAL SCREWS

TYPE A, 18-8 STAINLESS STEEL

DIAMETER	LENGTH	PART NO.	PRICE	DRIVER SIZE
#6	1/2	3.6A12PS	\$14.00	W3
	3/4	3.6A34PS	\$14.00	
	1	3.6A1PS	\$16.00	
	1-1/4	3.6A114PS	\$18.00	
	1-1/2	3.6A112PS	\$20.00	

DIAMETER	LENGTH	PART NO.	PRICE	DRIVER SIZE
#8	1/2	3.8A12PS	\$16.00	W4
	5/8*	3.8AB58PS	\$16.00	
	3/4	3.8A34PS	\$16.00	
	1	3.8A1PS	\$18.00	
	1-1/4	3.8A114PS	\$20.00	
1-1/2	3.8A112PS	\$24.00		

DIAMETER	LENGTH	PART NO.	PRICE	DRIVER SIZE
#10	1/2	3.10A12PS	\$18.00	W5
	3/4	3.10A34PS	\$20.00	
	1	3.10A1PS	\$22.00	

*Note: Sheet Metal Screws Type AB.

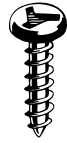

PAN HEAD/MACHINE SCREWS

18-8 STAINLESS STEEL

DIAMETER	LENGTH	PART NO.	PRICE	DRIVER SIZE
6-32	1/4	3.63214PS	\$12.00	W3
	3/8	3.63238PS	\$12.00	
	1/2	3.63212PS	\$12.00	
	3/4	3.63234PS	\$12.00	
	1	3.6321PS	\$14.00	

DIAMETER	LENGTH	PART NO.	PRICE	DRIVER SIZE
8-32	3/8	3.83238PS	\$14.00	W4
	1/2	3.83212PS	\$14.00	
	3/4	3.83234PS	\$14.00	
	1	3.8321PS	\$16.00	

DIAMETER	LENGTH	PART NO.	PRICE	DRIVER SIZE
10-32	1/2	3.10312PS	\$16.00	W5
	3/4	3.10334PS	\$16.00	
	1	3.1031PS	\$18.00	

DIAMETER	LENGTH	PART NO.	PRICE	DRIVER SIZE
10-24	1/2	3.10212PS	\$16.00	W5
	3/4	3.10234PS	\$16.00	
	1	3.1021PS	\$18.00	

OPSIT®

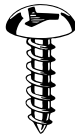

TRUSS HEAD/SHEET METAL LEFT-HANDED THREAD SCREWS

TYPE A, 18-8 STAINLESS STEEL

DIAMETER	LENGTH	PART NO.	PRICE	DRIVER SIZE
#8	1/2	3L.8A12TS	\$18.00	W4
	3/4	3L.8A34TS	\$20.00	
	1	3L.8A1TS	\$24.00	
	1-1/4	3L.8A114TS	\$28.00	
	1-1/2	3L.8A112TS	\$30.00	

DIAMETER	LENGTH	PART NO.	PRICE	DRIVER SIZE
#10	1/2	3L.10A12TS	\$20.00	W5
	3/4	3L.10A34TS	\$24.00	
	1	3L.10A1TS	\$28.00	
	1-1/4	3L.10A114TS	\$32.00	
	1-1/2	3L.10A112TS	\$36.00	

TP3 SCREWS



TRIANGULAR RECESS SCREWS PAN HEAD/SHEET METAL SCREWS

TYPE A, 410 STAINLESS STEEL

DIAMETER	LENGTH	PART NO.	PRICE	DRIVER SIZE
#8	1/2	8.8A12PS	\$24.00	TL1
	3/4	8.8A34PS	\$24.00	
	1	8.8A1PS	\$28.00	
	1-1/4	8.8A114PS	\$32.00	
	1-1/2	8.8A112PS	\$36.00	

DIAMETER	LENGTH	PART NO.	PRICE	DRIVER SIZE
#10	1/2	8.10A12PS	\$26.00	TL1
	3/4	8.10A34PS	\$30.00	
	1	8.10A1PS	\$32.00	
	1-1/4	8.10A114PS	\$42.00	
	1-1/2	8.10A112PS	\$46.00	
	2	8.10A2PS	\$50.00	

Manufacturers of OPSIT®

QUANTITY DISCOUNTS ON ONE-WAY, TRI-WING®, OPSIT® AND TP3 SECURITY SCREWS
 (Per Size) At 1m screws: less 10% • At 5m screws: less 20% • At 10m screws: less 30% • At 15m: Call for quote

CALL 516-931-1616 OR FAX 516-931-1654 • WWW.TAMPERPROOF.COM



METRIC SNAKE EYES®



PAN HEAD/MACHINE SCREWS

DIN 85, 18-8 STAINLESS STEEL

DIAMETER	LENGTH	PART NO.	PRICE	DRIVER SIZE
M3	6	1.M36PS	\$30.00	4
	8	1.M38PS	\$30.00	
	10	1.M310PS	\$30.00	
	12	1.M312PS	\$30.00	
	16	1.M316PS	\$30.00	
	20	1M320PS	\$30.00	

DIAMETER	LENGTH	PART NO.	PRICE	DRIVER SIZE
M3.5	6	1.M356PS	\$33.00	6
	12	1.M3512PS	\$33.00	

DIAMETER	LENGTH	PART NO.	PRICE	DRIVER SIZE
M4	5	1.M45PS	\$33.00	8
	6	1.M46PS	\$33.00	
	10	1.M410PS	\$33.00	
	12	1.M412PS	\$33.00	
	16	1.M416PS	\$33.00	
	20	1.M420PS	\$33.00	
	25	1.M425PS	\$33.00	

DIAMETER	LENGTH	PART NO.	PRICE	DRIVER SIZE
M5	12	1.M512PS	\$36.00	10
	16	1.M516PS	\$36.00	
	20	1.M520PS	\$36.00	
	25	1.M525PS	\$36.00	
	30	1.M530PS	\$36.00	

DIAMETER	LENGTH	PART NO.	PRICE	DRIVER SIZE
M6	12	1.M612PS	\$44.00	1/4
	14	1.M614PS	\$44.00	
	16	1.M616PS	\$44.00	
	20	1.M620PS	\$44.00	
	25	1.M625PS	\$48.00	
	30	1.M630PS	\$50.00	
	40	1.M640PS	\$60.00	



OVAL HEAD/MACHINE SCREWS

DIN 964, 18-8 STAINLESS STEEL

DIAMETER	LENGTH	PART NO.	PRICE	DRIVER SIZE
M3.5	10	1.M3510OS	\$33.00	6
	12	1.M3512OS	\$33.00	
	20	1.M3520OS	\$33.00	
	25	1.M3525OS	\$33.00	
	30	1.M3530OS	\$33.00	
	50	1.M3550OS	\$40.00	



FLAT HEAD/MACHINE SCREWS

DIN 963, 18-8 STAINLESS STEEL

DIAMETER	LENGTH	PART NO.	PRICE	DRIVER SIZE
M3	6	1.M36FS	\$30.00	4
	8	1.M38FS	\$30.00	
	10	1.M310FS	\$30.00	
	12	1.M312FS	\$30.00	
	16	1.M316FS	\$30.00	
	30	1.M330FS	\$36.00	

DIAMETER	LENGTH	PART NO.	PRICE	DRIVER SIZE
M4	10	1.M410FS	\$33.00	8
	12	1.M412FS	\$33.00	
	16	1.M416FS	\$33.00	
	20	1.M420FS	\$33.00	
	25	1.M425FS	\$33.00	
	35	1.M435FS	\$36.00	
50	1.M450FS	\$40.00		

DIAMETER	LENGTH	PART NO.	PRICE	DRIVER SIZE
M5	12	1.M512FS	\$36.00	10
	16	1.M516FS	\$36.00	
	20	1.M520FS	\$36.00	
	25	1.M525FS	\$36.00	
	30	1.M530FS	\$40.00	
35	1.M535FS	\$50.00		

DIAMETER	LENGTH	PART NO.	PRICE	DRIVER SIZE
M6	12	1.M612FS	\$44.00	1/4
	16	1.M616FS	\$44.00	
	20	1.M620FS	\$44.00	
	25	1.M625FS	\$48.00	
	30	1.M630FS	\$50.00	
	40	1.M640FS	\$60.00	

METRIC PHILLIPS



PHILLIPS PIN-HEAD SECURITY SCREWS

AVAILABLE UPON REQUEST

Sizes M3.5 Diameter to M6, in Pan Head (DIN 7985) and Flat Heads (DIN 65). Consult your salesperson.



ALL PRICES PER 100

See page 29 for matching tools.

TAMPERPROOF SCREW CO., INC. • FOR ADDITIONAL INFORMATION OR TO ORDER



METRIC CONVERSION

Any of our Sheet Metal Screws can be interchanged with a Metric equivalent. To determine size, consult the following chart.

DIAMETER (METRIC* TO AMERICAN)			
Metric 2.9	=	# 4	U.S. Standard
Metric 3.5	=	# 6	U.S. Standard
Metric 4.2	=	# 8	U.S. Standard
Metric 4.8	=	#10	U.S. Standard
Metric 5.5	=	#12	U.S. Standard
Metric 6.3	=	#14	U.S. Standard

LENGTHS (MILLIMETERS* TO INCHES)			
13 mm	=	1/2"	
19 mm	=	3/4"	
25 mm	=	1"	
32 mm	=	1-1/4"	
38 mm	=	1-1/2"	
50 mm	=	2"	
75 mm	=	3"	

*NOTE: Dimensions are approximate

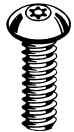

BUTTON HEAD/MACHINE SCREW

IFI STANDARDS
1 8 - 8 STAINLESS STEEL

DIAMETER	LENGTH	PART NO.	PRICE	DRIVER SIZE
M3	10	4.M310BS	\$40.00	T-10
	12	4.M312BS	\$40.00	
	16	4.M316BS	\$40.00	
M4	10	4.M410BS	\$36.00	T-15
	12	4.M412BS	\$36.00	
	16	4.M416BS	\$36.00	
	20	4.M420BS	\$40.00	
	25	4.M425BS	\$44.00	
M5	12	4.M512BS	\$50.00	T-25
	16	4.M516BS	\$50.00	
	20	4.M520BS	\$54.00	
	25	4.M525BS	\$60.00	
	30	4.M530BS	\$66.00	
M6	12	4.M612BS	\$60.00	T-27
	14	4.M614BS	\$88.00	
	20	4.M620BS	\$70.00	
	25	4.M625BS	\$72.00	
	30	4.M630BS	\$80.00	
	40	4.M640BS	\$88.00	



FLAT HEAD/MACHINE SCREW

IFI STANDARDS
1 8 - 8 STAINLESS STEEL

DIAMETER	LENGTH	PART NO.	PRICE	DRIVER SIZE
M3	6	4.M36FS	\$40.00	T-10
	8	4.M38FS	\$40.00	
	10	4.M310FS	\$40.00	
	12	4.M312FS	\$40.00	
	16	4.M316FS	\$40.00	
M3.5	8	4.M358FS	\$44.00	T-15
	10	4.M3510FS	\$44.00	
	12	4.M3512FS	\$44.00	
	20	4.M3520FS	\$44.00	
	25	4.M3525FS	\$44.00	
	30	4.M3530FS	\$44.00	
M4	8	4.M48FS	\$54.00	T-20
	10	4.M410FS	\$54.00	
	12	4.M412FS	\$54.00	
	16	4.M416FS	\$54.00	
	20	4.M420FS	\$54.00	
	25	4.M425FS	\$54.00	
	35	4.M435FS	\$54.00	
M5	12	4.M512FS	\$64.00	T-25
	16	4.M516FS	\$64.00	
	20	4.M520FS	\$64.00	
	25	4.M525FS	\$64.00	
	30	4.M530FS	\$64.00	
	35	4.M535FS	\$64.00	
M6	12	4.M612FS	\$88.00	T-30
	20	4.M620FS	\$88.00	
	25	4.M625FS	\$88.00	
	30	4.M630FS	\$88.00	
	40	4.M640FS	\$88.00	

QUANTITY DISCOUNTS ON METRIC SNAKE EYES® AND METRIC TORX®

(Per Size) At 1m screws: less 10% • At 5m screws: less 20% • At 10m screws: less 30% • at 15m: Call for quote



METRIC SOCKET SECURITY

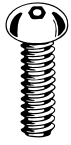

BUTTON HEAD/CAP SCREWS

1 8 - 8 STAINLESS STEEL

DIAMETER	LENGTH	PART NO.	PRICE	DRIVER SIZE
M3	6	6.M36BS	\$24.00	M2
	10	6.M310BS	\$24.00	
	16	6.M316BS	\$24.00	

DIAMETER	LENGTH	PART NO.	PRICE	DRIVER SIZE
M4	10	6.M410BS	\$36.00	M25
	12	6.M412BS	\$36.00	
	16	6.M416BS	\$36.00	
	20	6.M420BS	\$36.00	
	25	6.M425BS	\$36.00	

DIAMETER	LENGTH	PART NO.	PRICE	DRIVER SIZE
M5	12	6.M512BS	\$36.00	M3
	16	6.M516BS	\$36.00	
	20	6.M520BS	\$40.00	
	25	6.M525BS	\$42.00	
	30	6.M530BS	\$50.00	

DIAMETER	LENGTH	PART NO.	PRICE	DRIVER SIZE
M6	12	6.M612BS	\$60.00	5/32"
	16	6.M616BS	\$60.00	
	20	6.M620BS	\$60.00	
	40	6.M640BS	\$60.00	



FLAT HEAD/CAP SCREW

1 8 - 8 STAINLESS STEEL

DIAMETER	LENGTH	PART NO.	PRICE	DRIVER SIZE
M3	8	6.M38FS	\$24.00	M2
	10	6.M310FS	\$24.00	

DIAMETER	LENGTH	PART NO.	PRICE	DRIVER SIZE
M4	10	6.M410FS	\$36.00	M25
	12	6.M412FS	\$36.00	
	16	6.M416FS	\$36.00	
	20	6.M420FS	\$36.00	
	25	6.M425FS	\$36.00	

DIAMETER	LENGTH	PART NO.	PRICE	DRIVER SIZE
M5	12	6.M512FS	\$50.00	M3
	16	6.M516FS	\$50.00	
	20	6.M520FS	\$50.00	
	25	6.M525FS	\$50.00	
	30	6.M530FS	\$50.00	

DIAMETER	LENGTH	PART NO.	PRICE	DRIVER SIZE
M6	16	6.M616FS	\$60.00	5/32"
	20	6.M620FS	\$60.00	
	25	6.M625FS	\$60.00	
	30	6.M630FS	\$60.00	
	40	6.M640FS	\$60.00	

STANDARD TORX®



STANDARD TORX® NON-SECURITY PAN HEAD/SHEET METAL SCREWS

TYPE AB, 1 8 - 8 STAINLESS STEEL

DIAMETER	LENGTH	PART NO.	PRICE	DRIVER SIZE
#8	1/2	7.8AB12PS	\$22.00	T-20
	3/4	7.8AB34PS	\$24.00	
	1	7.8A1PS	\$27.00	
	1-1/4	7.8A114PS	\$34.00	

DIAMETER	LENGTH	PART NO.	PRICE	DRIVER SIZE
#10	1/2	7.10AB12PS	\$26.00	T-25
	3/4	7.10AB34PS	\$30.00	
	1	7.10AB1PS	\$33.00	
	1-1/4	7.10AB114PS	\$42.00	
	1-1/2	7.10AB112PS	\$44.00	



ALL PRICES PER 100

See pages 30 and 33 for matching tools.

TAMPERPROOF SCREW CO., INC. • FOR ADDITIONAL INFORMATION OR TO ORDER

TOOLS AND KITS

SPANNERS

BITS ONLY

SIZE	DIAMETER	PART NO.	PRICE
#4 Bit	(1/4" Hex)	1B.414	\$4.00 ea.
#4 Bit	(5/16" Hex)	1B.4516	\$4.00 ea.
#6 Bit	(1/4" Hex)	1B.614	\$4.00 ea.
#6 Bit	(5/16" Hex)	1B.6516	\$4.00 ea.
#8 Bit	(1/4" Hex)	1B.814	\$4.00 ea.
#8 Bit	(5/16" Hex)	1B.8516	\$4.00 ea.
#10 Bit	(1/4" Hex)	1B.1014	\$4.00 ea.
#10 Bit	(5/16" Hex)	1B.10516	\$4.00 ea.
#12 Bit	(1/4" Hex)	1B.1214	\$4.00 ea.
#12 Bit	(5/16" Hex)	1B.12516	\$4.00 ea.
#1/4 Bit	(1/4" Hex)	1B.1414	\$4.00 ea.
#1/4 Bit	(5/16" Hex)	1B.14516	\$4.00 ea.

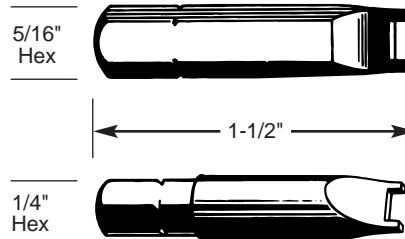

SPANNER BITS
Indicate size/hex shank when ordering

DRIVERS COMPLETE-HANDLE WITH BIT

SIZE	PART NO.	PRICE
#4 Driver	1D.4	\$10.00 ea.
#6 Driver	1D.6	\$10.00 ea.
#8 Driver	1D.8	\$10.00 ea.
#10 Driver	1D.10	\$10.00 ea.
#12 Driver	1D.12	\$10.00 ea.
#1/4 Driver	1D.14	\$10.00 ea.

SPANNER DRIVER KIT #SP5

SIZE	PART NO.	PRICE
#SP5 Driver Kit w/ 5 Bits (1/4" Hex)	SP5.14	\$30.00 ea.
#SP5 Driver Kit w/ 5 Bits (5/16" Hex)	SP5.516	\$30.00 ea.

1 Magnetic Hand Driver with 5 Spanner Bits
(Spanner Sizes 6, 8, 10, 12, 1/4) in a convenient vinyl pouch.

SPANNER DRIVER KIT #SP6

SIZE	PART NO.	PRICE
#SP6 Driver Kit w/ 6 Bits (1/4" Hex)	SP6.14	\$34.00 ea.
#SP6 Driver Kit w/ 6 Bits (5/16" Hex)	SP6.516	\$34.00 ea.

1 Magnetic Hand Driver with 6 Spanner Bits
(Spanner Sizes 4, 6, 8, 10, 12, 1/4) in a convenient vinyl pouch.

SPANNER NUTS-See page 13 for nuts, bits and matching tool.

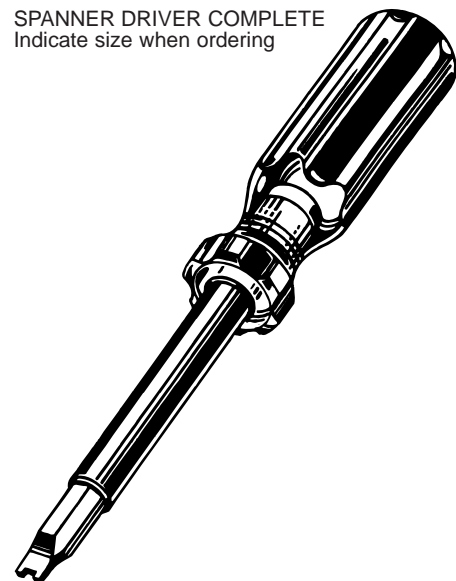

SPANNER DRIVER COMPLETE
Indicate size when ordering

Note: Tamper-Resistant Tools are NOT guaranteed against overtorque, misuse, breakage or wear and are not refundable.

QUANTITY DISCOUNTS ON TOOLS AND KITS
Call for details

CALL 516-931-1616 OR FAX 516-931-1654 • WWW.TAMPERPROOF.COM



TOOLS AND KITS

MAGNETIC HAND DRIVERS

FOR INTERCHANGEABLE BITS WITH STORAGE COMPARTMENTS

SIZE	PART NO.	PRICE
1/4" Hex-Drive	MAG14	\$12.00 ea.
5/16" Hex-Drive	MAG516	\$12.00 ea.

TRI-WING®

BITS ONLY

SIZE	DIAMETER	PART NO.	PRICE
W1 Bit Only	(1/4" Hex)	3B.W1	\$5.00 ea.
W2 Bit Only	(1/4" Hex)	3B.W2	\$5.00 ea.
W3 Bit Only	(1/4" Hex)	3B.W3	\$5.00 ea.
W4 Bit Only	(1/4" Hex)	3B.W4	\$5.00 ea.
W5 Bit Only	(1/4" Hex)	3B.W5	\$5.00 ea.

DRIVERS COMPLETE-HANDLE WITH BIT

SIZE	PART NO.	PRICE
W1 Driver	3D.W1	\$10.00 ea.
W2 Driver	3D.W2	\$10.00 ea.
W3 Driver	3D.W3	\$10.00 ea.
W4 Driver	3D.W4	\$10.00 ea.
W5 Driver	3D.W5	\$10.00 ea.

SOCKET PIN-HEAD

BITS ONLY

SIZE	DIAMETER	PART NO.	PRICE
3/32" Bit	(1/4" Hex)	6B.332	\$5.00 ea.
1/8" Bit	(1/4" Hex)	6B.18	\$5.00 ea.
5/32" Bit	(1/4" Hex)	6B.532	\$5.00 ea.
3/16" Bit	(1/4" Hex)	6B.316	\$5.00 ea.
7/32" Bit	(1/4" Hex)	6B.732	\$5.00 ea.

KEYS

SIZE		PART NO.	PRICE
3/32"	Key (Double-Ended)	6K.332	\$5.00 ea.
1/8"	Key (Double-Ended)	6K.18	\$5.00 ea.
5/32"	Key (Double-Ended)	6K.532	\$5.00 ea.
3/16"	Key (Double-Ended)	6K.316	\$5.00 ea.
7/32"	Key (Double-Ended)	6K.732	\$5.00 ea.
1/4"	Key (Single-Ended)	6K.14	\$6.00 ea.
5/16"	Key (Single-Ended)	6K.516	\$7.00 ea.
3/8"	Key (Single-Ended)	6K.38	\$8.00 ea.
M2	Key (Double-Ended)	6K.M2	\$5.00 ea.
M25	Key (Double-Ended)	6K.M25	\$5.00 ea.
M3	Key (Double-Ended)	6K.M3	\$5.00 ea.

MAGNETIC HAND DRIVER
Order bits separately

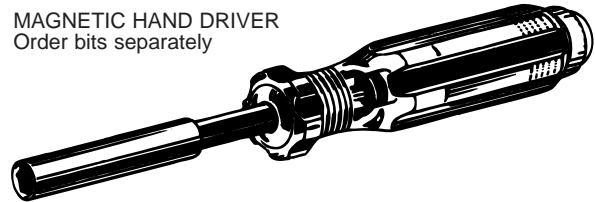

TRI-WING® BITS
Indicate size when ordering

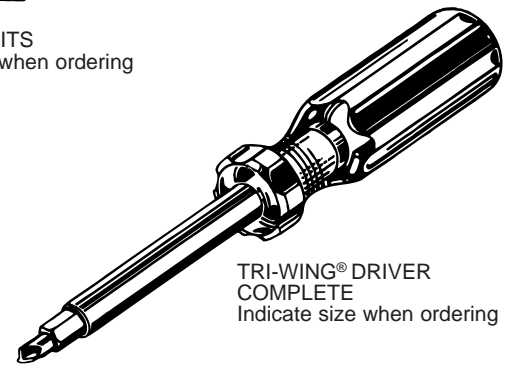

TRI-WING® DRIVER
COMPLETE
Indicate size when ordering



SOCKET PIN-HEAD BITS
Indicate size when ordering

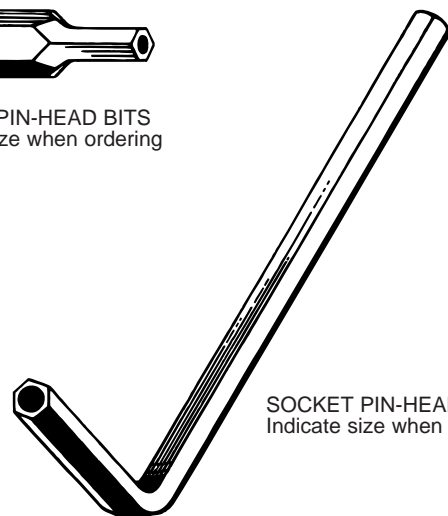

SOCKET PIN-HEAD KEYS
Indicate size when ordering



TOOLS AND KITS

SOCKET PIN-HEAD

DRIVERS COMPLETE-HANDLE WITH BIT

SIZE	PART NO.	PRICE
3/32" Driver	6D.332	\$10.00 ea.
1/8" Driver	6D.18	\$10.00 ea.
5/32" Driver	6D.532	\$10.00 ea.
3/16" Driver	6D.316	\$10.00 ea.
7/32" Driver	6D.732	\$10.00 ea.

HEX KEY KIT #HX4 AND HX5

SIZE	PART NO.	PRICE
#HX4 Kit with 4 Keys	HX4	\$14.00 ea.
#HX5 Kit with 5 Keys	HX5	\$18.00 ea.

#HX4 (Sizes 1/8", 5/32", 3/16", 7/32") in a vinyl pouch.

#HX5 (Sizes 3/32", 1/8", 5/32", 3/16", 7/32") in a vinyl pouch.

HEX BIT KIT #HX4B AND HX5B

SIZE	PART NO.	PRICE
#HX4B Kit w/ 4 Bits (1/4" Hex)	HX4B	\$14.00 ea.
#HX5B Kit w/ 5 Bits (1/4" Hex)	HX5B	\$18.00 ea.

#HX4B (Sizes 1/8", 5/32", 3/16", 7/32") in a vinyl pouch.

#HX5B (Sizes 3/32", 1/8", 5/32", 3/16", 7/32") in a vinyl pouch.

HEX BIT KIT #HX5DB

SIZE	PART NO.	PRICE
#HX5DB Driver Kit W/ 5 Bits	HX5DB	\$30.00 ea.

1 Magnetic Hand Driver with 5 Hex Bits

(Sizes 3/32", 1/8", 5/32", 3/16", 7/32") in a vinyl pouch.

PHILLIPS PIN-HEAD

BITS ONLY

SIZE	PART NO.	PRICE
#2 Bit Only (1/4" Hex)	2B.2	\$5.00 ea.
#3 Bit Only (1/4" Hex)	2B.3	\$5.00 ea.

DRIVERS COMPLETE-HANDLE WITH BIT

SIZE	PART NO.	PRICE
#2 Driver Complete	2D.2	\$10.00 ea.
#3 Driver Complete	2D.3	\$10.00 ea.

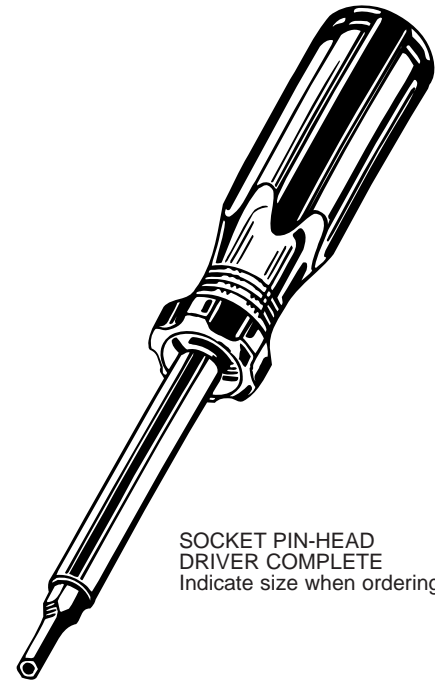

SOCKET PIN-HEAD
DRIVER COMPLETE
Indicate size when ordering



PHILLIPS PIN-HEAD BITS
Indicate size when ordering

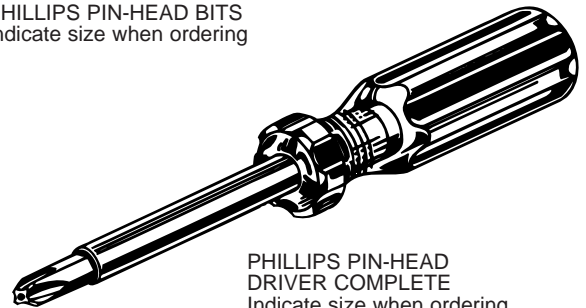

PHILLIPS PIN-HEAD
DRIVER COMPLETE
Indicate size when ordering

Note: Tamper-Resistant Tools are NOT guaranteed against overtorque, misuse, breakage or wear and are not refundable.

QUANTITY DISCOUNTS ON TOOLS AND KITS

Call for details

CALL 516-931-1616 OR FAX 516-931-1654 • WWW.TAMPERPROOF.COM



TOOLS AND KITS

TORX® TAMPERPROOF

BITS ONLY

SIZE	PART NO.	PRICE
T-7 Bit (1/4" Hex)	4B.T7	\$5.00 ea.
T-8 Bit (1/4" Hex)	4B.T8	\$5.00 ea.
T-9 Bit (1/4" Hex)	4B.T9	\$5.00 ea.
T-10 Bit (1/4" Hex)	4B.T10	\$5.00 ea.
T-15 Bit (1/4" Hex)	4B.T15	\$5.00 ea.
T-20 Bit (1/4" Hex)	4B.T20	\$5.00 ea.
T-25 Bit (1/4" Hex)	4B.T25	\$5.00 ea.
T-27 Bit (1/4" Hex)	4B.T27	\$5.00 ea.
T-30 Bit (1/4" Hex)	4B.T30	\$5.00 ea.
T-40 Bit (1/4" Hex)	4B.T40	\$5.00 ea.
T-45 Bit (5/16" Hex)	4B.T45	\$7.00 ea.
T-50 Bit (5/16" Hex)	4B.T50	\$8.00 ea.



TORX® TAMPERPROOF BIT
Indicate size when ordering

KEYS-BOTH ENDS DRILLED

SIZE		PART NO.	PRICE
T-7	(Double-Ended)	4K.T7	\$10.00 ea.
T-8	(Double-Ended)	4K.T8	\$10.00 ea.
T-9	(Double-Ended)	4K.T9	\$10.00 ea.
T-10	(Double-Ended)	4K.T10	\$6.00 ea.
T-15	(Double-Ended)	4K.T15	\$6.00 ea.
T-20	(Double-Ended)	4K.T20	\$6.00 ea.
T-25	(Double-Ended)	4K.T25	\$6.00 ea.
T-27	(Double-Ended)	4K.T27	\$7.00 ea.
T-30	(Double-Ended)	4K.T30	\$7.00 ea.
T-40	(Double-Ended)	4K.T40	\$9.00 ea.
T-45	(Double-Ended)	4K.T45	\$10.00 ea.

DRIVERS COMPLETE-HANDLE WITH BIT

SIZE	PART NO.	PRICE
T-7 Driver	4D.T7	\$10.00 ea.
T-8 Driver	4D.T8	\$10.00 ea.
T-9 Driver	4D.T9	\$10.00 ea.
T-10 Driver	4D.T10	\$10.00 ea.
T-15 Driver	4D.T15	\$10.00 ea.
T-20 Driver	4D.T20	\$10.00 ea.
T-25 Driver	4D.T25	\$10.00 ea.
T-27 Driver	4D.T27	\$10.00 ea.
T-30 Driver	4D.T30	\$10.00 ea.
T-40 Driver	4D.T40	\$10.00 ea.
T-45 Driver	4D.T45	\$12.00 ea.
T-50 Driver	4D.T50	\$14.00 ea.

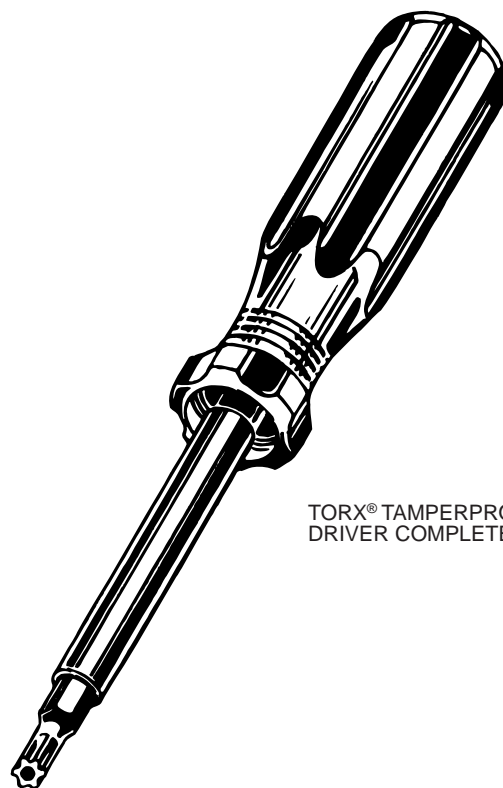

TORX® TAMPERPROOF
DRIVER COMPLETE



TOOLS AND KITS

TORX BIT KIT #TX7B AND TX9B

SIZE	PART NO.	PRICE
#TX7B Kit With 7 Bits (1/4" Hex)	TX7B	\$28.00 ea.
#TX9B Kit With 9 Bits (1/4" Hex)	TX7B	\$36.00 ea.

#TX7B (Sizes T8, T9, T10, T15, T20, T25, T27) in a vinyl pouch.
 #TX9B (Sizes T8, T9, T10, T15, T20, T25, T27, T30, T40) in a vinyl pouch.

TORX KEY KIT #TX5K

SIZE	PART NO.	PRICE
#TX5K Kit With 5 Keys	TX5K	\$28.00 ea.

Keys (Double-Ended) in sizes T10, T15, T20, T25, T27 in a vinyl pouch.

DRIVER KIT #TX7

SIZE	PART NO.	PRICE
#TX7 Driver Kit With 7 Bits	TX7	\$47.00 ea.

1 Magnetic Hand Driver with 7 Torx® Tamperproof Bits (Sizes T8, T9, T10, T15, T20, T25, T27) in a vinyl pouch.

DRIVER KIT #TX9

SIZE	PART NO.	PRICE
#TX9 Driver Kit With 9 Bits	TX9	\$56.00 ea.

1 Magnetic Hand Driver with 9 Torx® Tamperproof Bits (Sizes T8, T9, T10, T15, T20, T25, T27, T30, T40) in a vinyl pouch.

STANDARD TORX (NON-TAMPERPROOF)

STANDARD BITS ONLY	PART NO.	PRICE
T-20 1/4" Hex	7B.T20	\$1.50 ea.
T-25 1/4" Hex	7B.T25	\$1.50 ea.

TP3 TRIANGULAR RECESS SCREWS

BITS ONLY	PART NO.	PRICE
TL-1 1/4" Hex	8B.TL1	\$4.00 ea.

ONE-WAYS

"UN-DO-IT" REMOVAL TOOLS

SIZE	PART NO.	PRICE
#804 (Screw Sizes 6-8)	5.804	\$24.00 ea.
#807 (Screw Sizes 10-12)	5.807	\$24.00 ea.
#810 (Screw Sizes 1/4)	5.810	\$24.00 ea.

ONE-WAYS are easily installed with a standard screwdriver. Removal may be possible with the "Un-Do-It" removal tools.

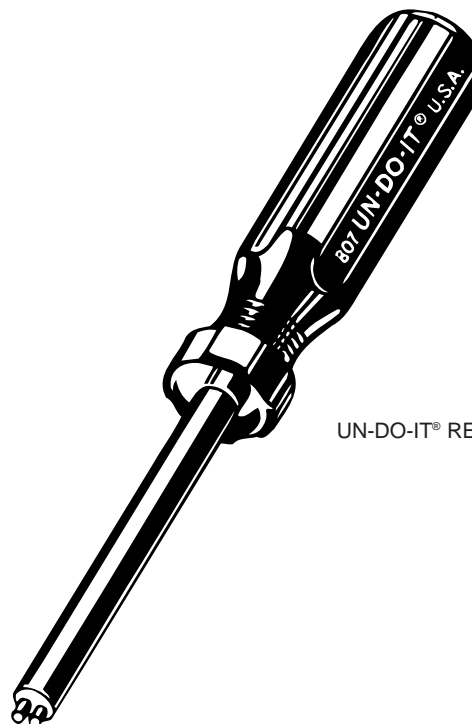

UN-DO-IT® REMOVAL TOOL

QUANTITY DISCOUNTS ON TOOLS AND KITS

Call for details



TOOLS AND KITS

COMPLETE TOOL KIT

#TSDK30

PART NO.	PRICE
TSDK30	\$140.00 ea.

Contains 31 assorted security bits plus 1 magnetic hand driver in a convenient plastic carrying case. Includes:

- Spanner Bits, #4, #6, #8, #10, #12, #1/4.
- Torx® Tamperproof Bits, T7, T8, T9, T10, T15, T20, T25, T27, T30, T40.
- Phillips Pin-Head Bits, #2, #3.
- Socket Pin-Head Bits, 3/32", 1/8", 5/32", 7/32", 3/16".
- Tri-Wing® Bits, W3, W4, W5.
- Square Drive Bits, R1, R2.
- 1 Spanner Nut Bit.
- 1 TP3 Triangular Recess Bit #TL1

All Bits and Driver in 1/4" Hex.

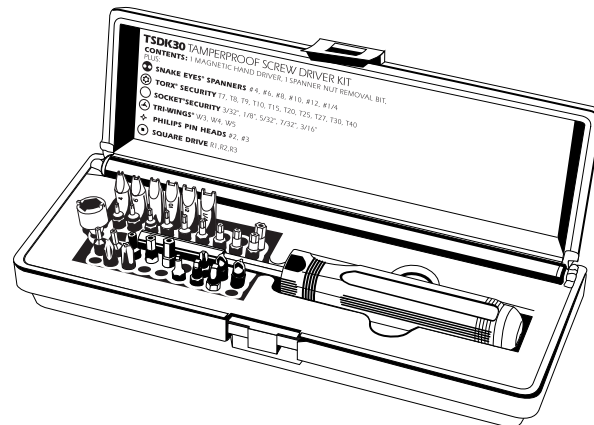

SPANNER SCREW KIT

#1000

PART NO.	PRICE
1.1000	\$260.00 ea.

Contains 20 most-wanted sizes of machine and wood/metal Snake Eyes® Spanner security screws. A total of 1,000 screws in stainless steel. Sizes 6, 8 and 10 in lengths from 1/2" to 1". Flat Heads and Pan Heads. Includes 3 special matching drivers. All in a sturdy steel storage box. Ideal for schools, prisons, museums, hospitals and other institutions.



TORX® SECURITY SCREW KIT

#1000

PART NO.	PRICE
4.1000	\$260.00 ea.

Contains 20 popular sizes of machine and wood/metal Torx® security screws. A total of 1,000 screws in stainless steel. Sizes 6, 8 and 10 in lengths from 1/2" to 1". Flat Heads and Button Heads. Includes four matching driver bits and magnetic hand driver. All in a sturdy steel storage box.



QUANTITY DISCOUNTS ON TOOLS AND KITS

Call for details

Note: Tamper-Resistant Tools are NOT guaranteed against overtorque, misuse, breakage or wear and are not refundable.

TAMPERPROOF SCREW CO., INC. • FOR ADDITIONAL INFORMATION OR TO ORDER