

# *Wrenches & Torque Wrenches*







# Adjustable Wrenches





## Adjustable Wrenches

ITEM NO.	Jaw Capacity mm	Length mm	Weight g	PCS 	G.W. KGS	CUFT 	CODE @
780128	13	100	60	288	19.5	2.80	001550
780192	19	150	130	144	21.5	2.28	001550
780256	24	200	260	72	20.5	1.70	001950
780320	28	250	400	54	26.5	1.64	002450
780384	33	300	660	36	24.0	1.82	003220
780480	42	380	1230	10	15.0	0.69	006650
780576	52	450	2020	5	12.0	0.46	012000



# Combination Wrenches



## Metric Combination Wrenches

ITEM NO.	Size mm	Length mm	Weight g	PCS 	G.W. KGS	CUFT 	CODE @
726006	6	102	20	240	6.0	0.30	000300
726007	7	107	25	240	6.5	0.30	000325
726008	8	112	30	240	8.0	0.30	000325
726009	9	123	35	240	9.0	0.30	000375
726010	10	140	45	300	15.0	0.52	000375
726011	11	150	65	300	20.5	0.52	000415
726012	12	158	70	300	22.5	0.52	000475
726013	13	171	80	150	13.0	0.52	000475
726014	14	186	110	150	17.0	0.52	000550
726015	15	198	135	150	21.0	0.52	000650
726016	16	206	140	100	15.0	0.41	000650
726017	17	224	180	100	19.0	0.41	000740
726018	18	224	180	100	19.0	0.41	000740
726019	19	248	235	60	15.0	0.52	000850
726020	20	277	285	60	18.0	0.52	000975
726021	21	277	285	60	18.0	0.52	000975
726022	22	295	320	60	20.0	0.52	001125
726023	23	295	320	60	20.0	0.52	001250
726024	24	320	400	30	13.0	0.45	001400
726025	25	342	470	30	15.0	0.45	001600
726026	26	342	435	30	14.0	0.45	001600
726027	27	370	600	30	19.0	0.45	001900
726030	30	410	750	20	16.0	0.43	002300
726032	32	430	900	20	19.0	0.43	002470
726033	33	461	970	20	20.5	0.84	003430
726034	34	461	970	20	20.5	0.84	003430
726035	35	461	970	20	20.5	0.84	003490
726036	36	486	1280	20	26.5	1.35	004460
726038	38	486	1280	20	26.5	1.35	004460
726040	40	540	1800	10	19.0	0.94	005660
726041	41	540	1800	10	19.0	0.94	005660
726042	42	540	1800	10	19.0	0.94	005660
726045	45	611	1900	10	20.0	1.22	006400
726046	46	611	1900	10	20.0	1.22	006400
726050	50	611	2350	10	24.5	1.22	007380
726055	55	666	4600	4	19.5	1.01	017570
726060	60	760	6170	4	26.0	1.18	023090
726065	65	760	6170	4	26.0	1.18	023090



# Combination Wrenches

## SAE Combination Wrenches

ITEM NO.	Size Inch	Length mm	Weight g	PCS 	G.W. KGS	CUFT 	CODE @
737008	1/4	102	20	240	6.0	0.30	000300
737010	5/16	112	30	240	8.5	0.30	000325
737012	3/8	140	45	240	12.0	0.30	000375
737014	7/16	150	65	300	20.0	0.52	000415
737016	1/2	171	95	150	15.0	0.52	000475
737018	9/16	186	110	150	17.0	0.52	000550
737020	5/8	206	155	100	16.5	0.41	000650
737022	11/16	224	180	100	19.5	0.62	000740
737024	3/4	248	235	60	15.0	0.52	000850
737026	13/16	277	285	60	18.0	0.52	000975
737028	7/8	295	320	60	20.0	0.52	001125
737030	15/16	320	400	30	13.0	0.45	001400
737032	1	342	450	30	14.5	0.45	001600
737034	1-1/16	370	585	30	18.5	0.45	001900
737036	1-1/8	393	700	20	15.0	0.43	002100
737040	1-1/4	430	850	20	18.0	0.43	002470
737042	1-5/16	461	970	20	20.5	0.84	003430
737044	1-3/8	461	970	20	20.5	0.84	003490
737046	1-7/16	486	1280	20	26.5	1.35	004460
737048	1-1/2	486	1280	20	26.5	1.35	004460
737052	1-5/8	540	1800	10	19.0	0.94	005660
737054	1-11/16	540	1800	10	19.0	0.94	005660
737056	1-3/4	611	1900	10	20.0	1.22	006400
737058	1-13/16	611	1900	10	20.0	1.22	006400
737060	1-7/8	611	2350	10	24.5	1.22	007380
737064	2	611	2350	10	24.5	1.22	007380
737068	2-1/8	665	4600	4	19.5	1.01	017570
737072	2-1/4	665	4600	4	19.5	1.01	017570
737076	2-3/8	760	6170	4	26.0	1.21	023090
737080	2-1/2	760	6170	4	26.0	1.21	023090



# Combination Wrench Sets

## HS-011M 11 Piece Metric Combination Wrench Set

Item No.	Description
<b>Combination Wrench:</b>	
726007	7mm Combination Wrench
726008	8mm Combination Wrench
726009	9mm Combination Wrench
726010	10mm Combination Wrench
726011	11mm Combination Wrench
726012	12mm Combination Wrench
726013	13mm Combination Wrench
726014	14mm Combination Wrench
726015	15mm Combination Wrench
726017	17mm Combination Wrench
726019	19mm Combination Wrench
Plastic Hook	
 1165 g	CODE : 005550
 12 Sets / 16 Kgs / 1.36 CUFT	

## HS-011S 11 Piece SAE Combination Wrench Set

Item No.	Description
<b>Combination Wrench:</b>	
737008	1/4" Combination Wrench
737010	5/16" Combination Wrench
737012	3/8" Combination Wrench
737014	7/16" Combination Wrench
737016	1/2" Combination Wrench
737018	9/16" Combination Wrench
737020	5/8" Combination Wrench
737022	11/16" Combination Wrench
737024	3/4" Combination Wrench
737026	13/16" Combination Wrench
737028	7/8" Combination Wrench
Plastic Hook	
 1635 g	CODE : 006750
 12 Sets / 21 Kgs / 1.38 CUFT	

## HS-007M 7 Piece Metric Combination Wrench Set

Item No.	Description
<b>Combination Wrench:</b>	
726010	10mm Combination Wrench
726012	12mm Combination Wrench
726014	14mm Combination Wrench
726017	17mm Combination Wrench
726019	19mm Combination Wrench
726022	22mm Combination Wrench
726024	24mm Combination Wrench
Plastic Tray(1/3)	
 1670 g	CODE : 005515
 3 Sets / 6 Kgs / 0.82 CUFT	

HS-007M





## HS-024M 24 Piece Metric Combination Wrench Set

Item No.	Description
<b>Combination Wrench:</b>	
726006	6mm Combination Wrench
726007	7mm Combination Wrench
726008	8mm Combination Wrench
726009	9mm Combination Wrench
726010	10mm Combination Wrench
726011	11mm Combination Wrench
726012	12mm Combination Wrench
726013	13mm Combination Wrench
726014	14mm Combination Wrench
726015	15mm Combination Wrench
726016	16mm Combination Wrench
726017	17mm Combination Wrench
726018	18mm Combination Wrench
726019	19mm Combination Wrench
726020	20mm Combination Wrench
726021	21mm Combination Wrench
726022	22mm Combination Wrench
726023	23mm Combination Wrench
726024	24mm Combination Wrench
Kit Bag	
 6000 g	CODE : 019800
 4 Sets / 27.5 Kgs / 1.19 CUFT	

HS-011M  
(HS-011S)



## HS-016S 16 Piece SAE Combination Wrench Set

Item No.	Description
<b>Combination Wrench:</b>	
737008	1/4" Combination Wrench
737010	5/16" Combination Wrench
737012	3/8" Combination Wrench
737014	7/16" Combination Wrench
737016	1/2" Combination Wrench
737018	9/16" Combination Wrench
737020	5/8" Combination Wrench
737022	11/16" Combination Wrench
737024	3/4" Combination Wrench
737026	13/16" Combination Wrench
737028	7/8" Combination Wrench
737030	15/16" Combination Wrench
737032	1" Combination Wrench
737034	1-1/16" Combination Wrench
737036	1-1/8" Combination Wrench
737040	1-1/4" Combination Wrench
Kit Bag	
 4500 g	CODE : 014250
 4 Sets / 21 Kgs / 1.01 CUFT	

HS-016S





HS-024M



# Double Ended Offset Ring Wrenches



## Metric Double Ended Offset Ring Wrenches

ITEM NO.	Size mm	Length mm	Weight g	PCS 	G.W. KGS	CUFT 	CODE @
740607	6 x 7	165	40	300	13	0.52	000750
740809	8 x 9	180	65	150	11	0.52	000780
741011	10 x 11	200	85	150	14	0.62	000810
741213	12 x 13	220	120	100	13	0.62	000950
741415	14 x 15	240	160	50	9	0.62	001050
741617	16 x 17	255	200	30	7	0.34	001230
741819	18 x 19	275	260	30	9	0.45	001440
742022	20 x 22	295	370	30	12	0.45	001620
742123	21 x 23	315	360	30	12	0.45	001670
742426	24 x 26	330	450	30	14.5	0.45	002070
742528	25 x 28	350	500	20	11	0.67	002220
742729	27 x 29	365	570	20	12.5	0.90	002660
743032	30 x 32	365	650	20	14	0.90	002880

## SAE Double Ended Offset Ring Wrenches

ITEM NO.	Size Inch	Length mm	Weight g	PCS 	G.W. KGS	CUFT 	CODE @
750810	1/4 x 5/16	170	50	150	8.5	0.52	000780
751214	3/8 x 7/16	200	90	150	14.5	0.62	000810
751618	1/2 x 9/16	230	160	50	9	0.62	001050
752022	5/8 x 11/16	260	200	30	7	0.34	001230
752426	3/4 x 13/16	285	290	30	10	0.45	001500
752830	7/8 x 15/16	315	420	30	13.5	0.45	001850
753234	1 x 1-1/16	350	500	20	11	0.67	002250
753640	1-1/8 x 1-1/4	360	650	20	14	0.90	002900

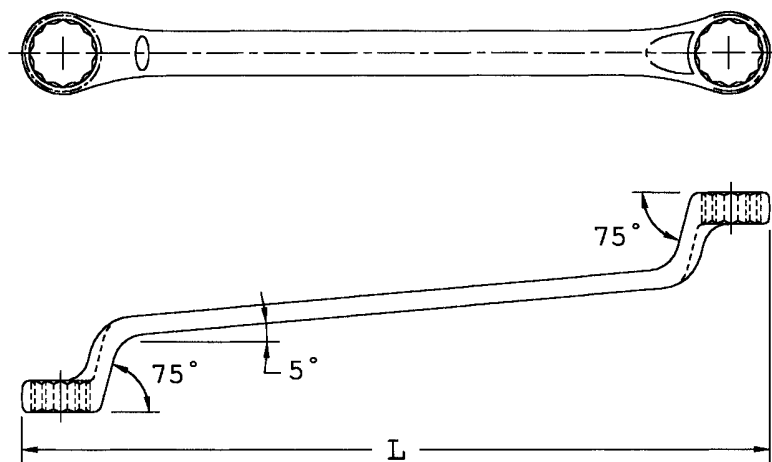

# Double Ended Offset Ring Wrench Sets

## DE-713M 13 Piece Metric Double Ended Offset Ring Wrench Set

Item No. Description

### Double Ended Offset Ring Wrench:

740607	6 x 7mm Double Ended Offset Ring Wrench
740809	8 x 9mm Double Ended Offset Ring Wrench
741011	10 x 11mm Double Ended Offset Ring Wrench
741213	12 x 13mm Double Ended Offset Ring Wrench
741415	14 x 15mm Double Ended Offset Ring Wrench
741617	16 x 17mm Double Ended Offset Ring Wrench
741819	18 x 19mm Double Ended Offset Ring Wrench
742022	20 x 22mm Double Ended Offset Ring Wrench
742123	21 x 23mm Double Ended Offset Ring Wrench
742426	24 x 26mm Double Ended Offset Ring Wrench
742528	25 x 28mm Double Ended Offset Ring Wrench
742729	27 x 29mm Double Ended Offset Ring Wrench
743032	30 x 32mm Double Ended Offset Ring Wrench

Kit Bag

 4330 g CODE : 018200

 6 Sets / 23 Kgs / 1.70 CUFT

## DE-708M 8 Piece Metric Double Ended Offset Ring Wrench Set

Item No. Description

### Double Ended Offset Ring Wrench:

740607	6 x 7mm Double Ended Offset Ring Wrench
740809	8 x 9mm Double Ended Offset Ring Wrench
741011	10 x 11mm Double Ended Offset Ring Wrench
741213	12 x 13mm Double Ended Offset Ring Wrench
741415	14 x 15mm Double Ended Offset Ring Wrench
741617	16 x 17mm Double Ended Offset Ring Wrench
741819	18 x 19mm Double Ended Offset Ring Wrench
742022	20 x 22mm Double Ended Offset Ring Wrench

Kit Bag

 1450 g CODE : 008100

 9 Sets / 14 Kgs / 1.90 CUFT

## DE-708S 8 Piece SAE Double Ended Offset Ring Wrench Set

Item No. Description

### Double Ended Offset Ring Wrench:

750810	1/4 x 5/16" Double Ended Offset Ring Wrench
751214	3/8 x 7/16" Double Ended Offset Ring Wrench
751618	1/2 x 9/16" Double Ended Offset Ring Wrench
752022	5/8 x 11/16" Double Ended Offset Ring Wrench
752426	3/4 x 13/16" Double Ended Offset Ring Wrench
752830	7/8 x 15/16" Double Ended Offset Ring Wrench
753234	1 x 1-1/16" Double Ended Offset Ring Wrench
753640	1-1/8 x 1-1/4" Double Ended Offset Ring Wrench

Kit Bag

 2670 g CODE : 011500

 9 Sets / 21 Kgs / 1.90 CUFT

## DE-706S 6 Piece SAE Double Ended Offset Ring Wrench Set

Item No. Description

### Double Ended Offset Ring Wrench:

750810	1/4 x 5/16" Double Ended Offset Ring Wrench
751214	3/8 x 7/16" Double Ended Offset Ring Wrench
751618	1/2 x 9/16" Double Ended Offset Ring Wrench
752022	5/8 x 11/16" Double Ended Offset Ring Wrench
752426	3/4 x 13/16" Double Ended Offset Ring Wrench
752830	7/8 x 15/16" Double Ended Offset Ring Wrench

Kit Bag

 1400 g CODE : 006900

 9 Sets / 13.5 Kgs / 1.90 CUFT

DE-713M

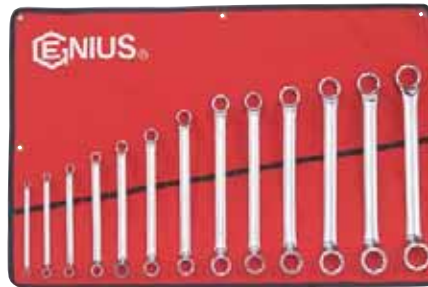

DE-708M



DE-708S





DE-706S







# Flare Nut Wrenches

## Metric Flare Nut Wrenches

ITEM NO.	Size mm	D1 mm	D2 mm	Length mm	Weight g	PCS 	G.W. KGS	CUFT 	CODE @
740911	9 x 11	20	22	127	70	150	11.5	0.52	001090
741012	10 x 12	21	23	141	65	150	11	0.52	001120
741314	13 x 14	24	26	157	85	150	14	0.52	001180
741517	15 x 17	27	30	173	135	100	14.5	0.62	001350
741618	16 x 18	28	30	181	135	100	14.5	0.62	001490
741921	19 x 21	33	36	194	200	100	21	0.62	001780

## SAE Flare Nut Wrenches

ITEM NO.	Size Inch	D1 mm	D2 mm	Length mm	Weight g	PCS 	G.W. KGS	CUFT 	CODE @
760810	1/4 x 5/16	16	18	105	40	150	7	0.52	001090
761214	3/8 x 7/16	21	22	133	70	150	11.5	0.52	001120
761618	1/2 x 9/16	24	26	157	90	150	14.5	0.52	001300
762022	5/8 x 11/16	28	30	181	135	100	14.5	0.62	001490
762428	3/4 x 7/8	32	37	193	200	100	21	0.62	001780

### FN-006M 6 Piece Metric Flare Nut Wrench Set

Item No. Description

Flare Nut Wrenches:

740911	9mm x 11mm Flare Nut Wrench
741012	10mm x 12mm Flare Nut Wrench
741314	13mm x 14mm Flare Nut Wrench
741517	15mm x 17mm Flare Nut Wrench
741618	16mm x 18mm Flare Nut Wrench
741921	19mm x 21mm Flare Nut Wrench

Kit Bag

 840 g      CODE : 007300

 12 Sets / 11 Kgs / 0.63 CUFT

### FN-005S 5 Piece SAE Flare Nut Wrench Set

Item No. Description

Flare Nut Wrenches:

760810	1/4" x 5/16" Flare Nut Wrench
761214	3/8" x 7/16" Flare Nut Wrench
761618	1/2" x 9/16" Flare Nut Wrench
762022	5/8" x 11/16" Flare Nut Wrench
762428	3/4" x 7/8" Flare Nut Wrench

Kit Bag

 670 g      CODE : 006200

 12 Sets / 9 Kgs / 0.63 CUFT

FN-006M





FN-005S





# Shpd Wrenches

## Metric Shpd Wrenches

ITEM NO.	Size mm	L1 mm	Length mm	Weight g	PCS 	G.W. KGS	CUFT 	CODE @
570515	1.5	14	45	1	600	2	0.30	000100
570520	2	16	50	2	600	2	0.30	000100
570625	2.5	18	56	3	600	3	0.30	000115
570630	3	20	62	5	360	3	0.30	000120
570735	3.5	23	66	10	360	4.5	0.30	000120
570740	4	25	70	10	360	4.5	0.30	000120
570845	4.5	27	75	15	200	4	0.59	000120
570850	5	28	80	20	200	5	0.59	000135
570855	5.5	30	85	25	200	6	0.59	000140
570960	6	32	90	30	200	7	0.59	000140
570970	7	34	93	40	200	9	0.59	000175
571080	8	36	100	60	100	7	0.59	000210
571190	9	38	109	80	100	9	0.59	000260
571210	10	40	112	105	100	11.5	0.59	000275
571211	11	42	118	130	100	14	0.59	000345
571312	12	45	125	170	100	18	0.59	000355
571313	13	50	132	230	100	24	0.59	000395
571414	14	55	140	265	100	27.5	0.59	000550
571516	16	60	150	380	50	20	0.62	000730
571617	17	63	160	440	50	23	0.62	000800
571719	19	70	175	620	30	19.5	0.52	000940





## SAE Shpd Wrenches

ITEM NO.	Size Inch	L1 mm	Length mm	Weight g	PCS 	G.W. KGS	CUFT 	CODE @
590503	1/20	12	50	1	600	2	0.30	000115
590504	1/16	13	53	1	600	2	0.30	000115
590605	5/64	15	56	2	600	2	0.30	000115
590606	3/32	17	58	3	600	3	0.30	000120
590607	7/64	18	60	5	360	3	0.30	000120
590608	1/8	20	62	6	360	3	0.30	000120
590709	9/64	22	65	8	360	4	0.30	000120
590710	5/32	25	70	10	360	4.5	0.30	000120
590812	3/16	26	75	15	200	4	0.59	000135
590814	7/32	28	80	20	200	5	0.59	000140
590916	1/4	32	85	30	200	7	0.59	000140
591020	5/16	36	100	60	100	7	0.59	000210
591124	3/8	40	110	90	100	10	0.59	000270
591328	7/16	46	125	140	100	15	0.59	000345
591432	1/2	56	140	215	100	22.5	0.59	000395
591536	9/16	56	145	280	50	15	0.62	000605
591540	5/8	58	150	380	50	20	0.62	000765
591644	11/16	63	160	440	50	23	0.62	000860
591848	3/4	70	175	620	30	19.5	0.52	000940



# Shapdo Wrenches

## Metric Shapdo Wrenches

ITEM NO.	Size mm	L1 mm	Length mm	Weight g	PCS 	G.W. KGS	CUFT 	CODE @
570915L	1.5	14	88	2	360	2	0.30	000160
571020L	2	16	98	3	360	2	0.30	000160
571125L	2.5	18	112	5	240	2.5	0.30	000190
571230L	3	20	125	8	240	3	0.30	000200
571335L	3.5	23	130	12	200	3.5	0.59	000200
571440L	4	25	140	20	200	5	0.59	000200
571545L	4.5	27	150	25	200	6	0.59	000200
571650L	5	28	160	30	200	7	0.59	000230
571760L	6	32	175	50	150	8.5	0.52	000240
571870L	7	34	185	75	150	12.5	0.52	000290
572080L	8	36	200	100	100	11	0.41	000350
572190L	9	38	210	140	100	15	0.62	000430
572210L	10	40	225	180	100	19	0.62	000460
572411L	11	42	240	230	100	24	0.62	000580
572512L	12	45	250	275	60	17.5	0.52	000600
572613L	13	50	260	390	60	24.5	0.52	000660
572814L	14	55	280	450	30	14.5	0.45	000920
572916L	16	60	295	700	30	22	0.45	001200
573117L	17	63	310	735	30	23	0.45	001330
573219L	19	70	325	980	20	20.5	0.45	001560



## SAE Shapdo Wrenches

ITEM NO.	Size Inch	L1 mm	Length mm	Weight g	PCS 	G.W. KGS	CUFT 	CODE @
590803L	1/20	12	85	2	360	2	0.30	000190
590904L	1/16	13	88	2	360	2	0.30	000190
591005L	5/64	15	98	3	360	2	0.30	000190
591106L	3/32	17	110	5	240	2.5	0.30	000200
591208L	1/8	20	125	8	240	3	0.30	000200
591310L	5/32	25	130	12	200	3.5	0.59	000200
591512L	3/16	26	150	25	200	6	0.59	000230
591614L	7/32	28	160	30	200	7	0.59	000240
591816L	1/4	32	175	50	150	8.5	0.52	000240
592020L	5/16	36	200	100	100	11	0.41	000350
592324L	3/8	40	225	175	100	18.5	0.62	000450
592428L	7/16	46	240	230	100	24	0.62	000580
592632L	1/2	56	260	380	60	24	0.52	000660
592836L	9/16	56	280	460	30	15	0.45	001000
593040L	5/8	58	295	680	30	21.5	0.45	001270
593144L	11/16	63	310	750	30	23.5	0.45	001430
593248L	3/4	70	325	980	20	20.5	0.45	001560

# L-Shaped Hex Wrench Sets

## HK-009M 9 Piece Metric Hex Wrench Set

Item No. Description

Hex Wrench:

570515	1.5mm Hex Wrench
570520	2mm Hex Wrench
570625	2.5mm Hex Wrench
570630	3mm Hex Wrench
570740	4mm Hex Wrench
570850	5mm Hex Wrench
570960	6mm Hex Wrench
571080	8mm Hex Wrench
571210	10mm Hex Wrench

Plastic Holder

 310 g CODE : 000825

 72 Sets / 23.5 Kgs / 1.88 CUFT

## HK-009S 9 Piece SAE Hex Wrench Set

Item No. Description

Hex Wrench:

590504	1/16" Hex Wrench
590605	5/64" Hex Wrench
590606	3/32" Hex Wrench
590608	1/8" Hex Wrench
590710	5/32" Hex Wrench
590812	3/16" Hex Wrench
590916	1/4" Hex Wrench
591020	5/16" Hex Wrench
591124	3/8" Hex Wrench

Plastic Holder

 300 g CODE : 000825

 72 Sets / 22.5 Kgs / 1.88 CUFT

## HK-025MS 25 Piece SAE & Metric Hex Wrench Set

Item No. Description

Metric Hex Wrench:

570515	1.5mm Hex Wrench
570520	2mm Hex Wrench
570625	2.5mm Hex Wrench
570630	3mm Hex Wrench
570740	4mm Hex Wrench
570845	4.5mm Hex Wrench
570850	5mm Hex Wrench
570855	5.5mm Hex Wrench
570960	6mm Hex Wrench
570970	7mm Hex Wrench
571080	8mm Hex Wrench
571190	9mm Hex Wrench
571210	10mm Hex Wrench

SAE Hex Wrench:

590504	1/16" Hex Wrench
590605	5/64" Hex Wrench
590606	3/32" Hex Wrench
590607	7/64" Hex Wrench
590608	1/8" Hex Wrench
590709	9/64" Hex Wrench
590710	5/32" Hex Wrench
590812	3/16" Hex Wrench
590814	7/32" Hex Wrench
590916	1/4" Hex Wrench
591020	5/16" Hex Wrench
591124	3/8" Hex Wrench

Kit Bag

 835 g CODE : 001450

 24 Sets / 21 Kgs / 0.92 CUFT

## HK-010M 10 Piece Metric Hex Wrench Set

Item No. Description

Hex Wrench:

570515	1.5mm Hex Wrench
570520	2mm Hex Wrench
570625	2.5mm Hex Wrench
570630	3mm Hex Wrench
570740	4mm Hex Wrench
570850	5mm Hex Wrench
570855	5.5mm Hex Wrench
570960	6mm Hex Wrench
571080	8mm Hex Wrench
571210	10mm Hex Wrench

Plastic Holder

 310 g CODE : 000600

 72 Sets / 23.5 Kgs / 1.44 CUFT

## HK-010S 10 Piece SAE Hex Wrench Set

Item No. Description

Hex Wrench:

590504	1/16" Hex Wrench
590605	5/64" Hex Wrench
590606	3/32" Hex Wrench
590608	1/8" Hex Wrench
590710	5/32" Hex Wrench
590812	3/16" Hex Wrench
590814	7/32" Hex Wrench
590916	1/4" Hex Wrench
591020	5/16" Hex Wrench
591124	3/8" Hex Wrench

Plastic Holder

 300 g CODE : 000600

 72 Sets / 22.5 Kgs / 1.44 CUFT

## HK-007MF 7 Piece Metric Hex Wrench Folding Set

Item No. Description

Metric Hex Wrench:

1.27, 1.5, 2, 2.5, 3, 4 & 5mm
-------------------------------

Slide Card

 130 g CODE : 000615

 144 Sets / 21 Kgs / 2.00 CUFT

## HK-009SF 9 Piece SAE Hex Wrench Folding Set

Item No. Description

SAE Hex Wrench:

3/64, 1/16, 5/64, 3/32, 7/64, 1/8, 9/64, 5/32 & 3/16"
---

Slide Card

 130 g CODE : 000675

 144 Sets / 21 Kgs / 2.00 CUFT



HK-009SF



HK-007MF



HK-010M  
(HK-010S)

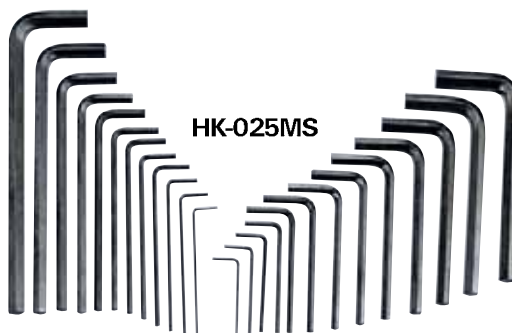

HK-025MS



HK-009M  
(HK-009S)

# L-Shaped Wb Hex Wrenches



## Metric L-Shaped Wb Hex Wrenches

ITEM NO.	Size mm	L1 mm	Length mm	Weight g	PCS 	G.W. KGS	CUFT 	CODE @
570915B	1.5	14	88	2	360	2	0.30	000200
571020B	2	16	98	3	360	2	0.30	000200
571125B	2.5	18	112	5	240	2.5	0.30	000230
571230B	3	20	125	8	240	3	0.30	000240
571335B	3.5	23	130	12	200	3.5	0.59	000240
571440B	4	25	140	18	200	4.5	0.59	000240
571545B	4.5	27	150	24	200	6	0.59	000240
571650B	5	28	160	32	200	7.5	0.59	000270
571760B	6	32	175	49	150	8.5	0.52	000280
571870B	7	34	185	73	150	12	0.52	000350
572080B	8	36	200	99	100	11	0.41	000420
572190B	9	38	210	140	100	15	0.62	000520
572210B	10	40	225	180	100	19	0.62	000550

## SA L-Shaped Wb Hex Wrenches

ITEM NO.	Size Inch	L1 mm	Length mm	Weight g	PCS 	G.W. KGS	CUFT 	CODE @
590904B	1/16	13	88	2	360	2	0.30	000230
591005B	5/64	15	98	3	360	2	0.30	000230
591106B	3/32	17	110	5	240	2.5	0.30	000240
591208B	1/8	20	125	8	240	3	0.30	000240
591310B	5/32	25	130	12	200	3.5	0.59	000240
591512B	3/16	26	150	24	200	6	0.59	000270
591614B	7/32	28	160	32	200	7.5	0.59	000280
591816B	1/4	32	175	52	150	8.5	0.52	000280
592020B	5/16	36	200	99	100	11	0.41	000420
592324B	3/8	40	225	175	100	18.5	0.62	000540



HK-009MB  
(HK-009SB)

### HK-009MB 9 Piece Metric Wobble Hex Wrench Set

Item No. Description

**Wobble Hex Wrench:**

- 570915B 1.5mm Wobble Hex Wrench
- 571020B 2mm Wobble Hex Wrench
- 571125B 2.5mm Wobble Hex Wrench
- 571230B 3mm Wobble Hex Wrench
- 571440B 4mm Wobble Hex Wrench
- 571650B 5mm Wobble Hex Wrench
- 571760B 6mm Wobble Hex Wrench
- 572080B 8mm Wobble Hex Wrench
- 572210B 10mm Wobble Hex Wrench

Plastic Holder

485 g CODE : 001775

36 Sets / 19 Kgs / 1.70 CUFT

### HK-009SB 9 Piece SAE Wobble Hex Wrench Set

Item No. Description

**Wobble Hex Wrench:**

- 590904B 1/16" Wobble Hex Wrench
- 591005B 5/64" Wobble Hex Wrench
- 591106B 3/32" Wobble Hex Wrench
- 591208B 1/8" Wobble Hex Wrench
- 591310B 5/32" Wobble Hex Wrench
- 591512B 3/16" Wobble Hex Wrench
- 591816B 1/4" Wobble Hex Wrench
- 592020B 5/16" Wobble Hex Wrench
- 592324B 3/8" Wobble Hex Wrench



Plastic Holder

485 g CODE : 001775

36 Sets / 19 Kgs / 1.70 CUFT



# L-Shaped Star Wrenches

## L-Shaped Star Wrenches

ITEM NO.	Size	L1 mm	Length mm	Weight g	PCS 	G.W. KGS	CUFT 	CODE @
580506	T-6	16	42	2	600	2	0.30	000180
580507	T-7	16	48	3	600	3	0.30	000180
580508	T-8	16	48	3	600	3	0.30	000180
580509	T-9	16	48	4	600	3.5	0.30	000190
580510	T-10	17	51	4	600	3.5	0.30	000200
580615	T-15	18	54	5	600	4	0.30	000210
580620	T-20	20	57	7	600	5	0.30	000220
580625	T-25	20	60	10	360	4.5	0.30	000250
580627	T-27	21	63	16	360	6.5	0.30	000260
580730	T-30	24	70	20	360	8	0.30	000270
580840	T-40	26	76	30	200	7	0.59	000280
580845	T-45	28	82	43	200	9.5	0.59	000340
580950	T-50	31	94	61	200	13	0.59	000370
581055	T-55	35	108	120	100	13	0.59	000530
581260	T-60	38	120	185	100	19.5	0.59	000720
581470	T-70	45	138	250	100	26	0.59	000970



## L-Shaped Tamperproof Star wrenches

ITEM NO.	Size Inch	L1 mm	Length mm	Weight g	PCS 	G.W. KGS	CUFT 	CODE @
580807T	T-7	16	75	4	360	2.5	0.30	000260
580808T	T-8	16	77	5	360	3	0.30	000260
580809T	T-9	16	80	6	360	3	0.30	000270
580910T	T-10	17	85	6	360	3	0.30	000280
580915T	T-15	18	90	8	360	4	0.30	000290
581020T	T-20	20	95	10	240	3.5	0.30	000300
581025T	T-25	20	100	15	240	4.5	0.30	000350
581127T	T-27	21	105	24	200	6	0.59	000360
581230T	T-30	24	115	30	200	7	0.59	000370
581240T	T-40	26	125	45	150	7.5	0.52	000400
581345T	T-45	28	130	62	100	7	0.41	000480
581550T	T-50	31	150	88	100	10	0.62	000530
581755T	T-55	35	170	170	100	18	0.62	000760
581960T	T-60	38	190	265	60	17	0.52	001020
582270T	T-70	45	220	360	60	22.5	0.52	001380

### SK-010T 10 Piece Tamperproof Star Wrench Set

Item No. Description

**Tamperproof Star Wrench:**

- 580809T T-9 Tamperproof Star Wrench
- 580910T T-10 Tamperproof Star Wrench
- 580915T T-15 Tamperproof Star Wrench
- 581020T T-20 Tamperproof Star Wrench
- 581025T T-25 Tamperproof Star Wrench
- 581127T T-27 Tamperproof Star Wrench
- 581230T T-30 Tamperproof Star Wrench
- 581240T T-40 Tamperproof Star Wrench
- 581345T T-45 Tamperproof Star Wrench
- 581550T T-50 Tamperproof Star Wrench

Plastic Holder

 480 g      CODE : 002300

 36 Sets / 19.5 Kgs / 1.80 CUFT

SK-010T



# Star Set

## TX-2356 56 Piece Complete Star Type Wrench Set

Item No.	Description	Item No.	Description
<b>1/4" Dr. Star Hand Socket:</b>			
252504	E-4 Star Hand Socket	580508	T-8 L-Shaped Star Wrench
252505	E-5 Star Hand Socket	580509	T-9 L-Shaped Star Wrench
252506	E-6 Star Hand Socket	580510	T-10 L-Shaped Star Wrench
252507	E-7 Star Hand Socket	580615	T-15 L-Shaped Star Wrench
252508	E-8 Star Hand Socket	580620	T-20 L-Shaped Star Wrench
<b>3/8" Dr. Star Hand Socket:</b>			
353510	E-10 Star Hand Socket	580625	T-25 L-Shaped Star Wrench
353511	E-11 Star Hand Socket	580627	T-27 L-Shaped Star Wrench
353512	E-12 Star Hand Socket	580730	T-30 L-Shaped Star Wrench
353514	E-14 Star Hand Socket	580840	T-40 L-Shaped Star Wrench
353516	E-16 Star Hand Socket	580845	T-45 L-Shaped Star Wrench
353518	E-18 Star Hand Socket	580950	T-50 L-Shaped Star Wrench
353520	E-20 Star Hand Socket	581055	T-55 L-Shaped Star Wrench
<b>Tamperproof Star Bit 30mmL:</b>			
7107	T-7 Tamperproof Star Bit	581260	T-60 L-Shaped Star Wrench
7108	T-8 Tamperproof Star Bit	581470	T-70 L-Shaped Star Wrench
7109	T-9 Tamperproof Star Bit	<b>Star Screwdriver:</b>	
7110	T-10 Tamperproof Star Bit	592 + 6606	T-6 Star Screwdriver
7115	T-15 Tamperproof Star Bit	592 + 6607	T-7 Star Screwdriver
7120	T-20 Tamperproof Star Bit	592 + 6608	T-8 Star Screwdriver
7125	T-25 Tamperproof Star Bit	592 + 6609	T-9 Star Screwdriver
7127	T-27 Tamperproof Star Bit	593 + 6710	T-10 Star Screwdriver
7130	T-30 Tamperproof Star Bit	593 + 6715	T-15 Star Screwdriver
7140	T-40 Tamperproof Star Bit	593 + 6720	T-20 Star Screwdriver
<b>3/8" Dr. Tamperproof Star Bit Socket 50mmL:</b>			
310 + 7145	T-45 Tamperproof Star Bit Socket	563 + 6725	T-25 Star Screwdriver
310 + 7150	T-50 Tamperproof Star Bit Socket	594 + 6827	T-27 Star Screwdriver
340 + 7155	T-55 Tamperproof Star Bit Socket	594 + 6830	T-30 Star Screwdriver
<b>L-Shaped Star Wrench:</b>			
580506	T-6 L-Shaped Star Wrench	595 + 6840	T-40 Star Screwdriver
580507	T-7 L-Shaped Star Wrench	595 + 6845	T-45 Star Screwdriver
		595 + 6850	T-50 Star Screwdriver
		<b>Accessory:</b>	
		283508	Bit Holder
		380371	1/4" & 3/8" Double Drive Ratchet
			Blow Case

3650 g 4 Sets / 15.5 Kgs / 1.07 CUFT CODE : 020200

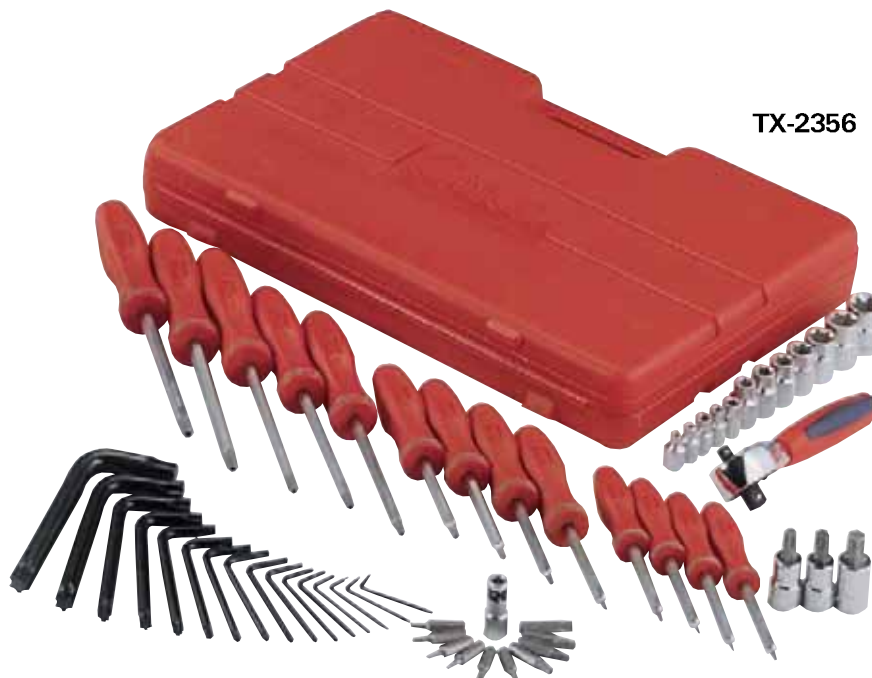

TX-2356

# Snap On Square Wbs



## Snap On Square Wbs

ITEM NO.	Size	L1 mm	Length mm	Weight g	PCS 	G.W. KGS	CUFT 	CODE @
582705M	M5	25	72	15	240	4.5	0.30	000260
582806M	M6	28	80	30	240	8	0.30	000285
582908M	M8	32	90	50	150	8.5	0.52	000390
583010M	M10	36	100	85	150	14	0.52	000530
583112M	M12	40	112	130	150	20.5	0.52	000635
583214M	M14	45	125	200	60	13	0.34	000865
583416M	M16	55	140	300	60	19	0.34	001175

### HK-007TS 7 Piece Triple Square Wrench Set

Item No. Description

**Triple Square Wrench:**

- 582705M M5 Triple Square Wrench
- 582806M M6 Triple Square Wrench
- 582908M M8 Triple Square Wrench
- 583010M M10 Triple Square Wrench
- 583112M M12 Triple Square Wrench
- 583214M M14 Triple Square Wrench
- 583416M M16 Triple Square Wrench

920 g      CODE : 003520

20 Sets / 19.5 Kgs / 1.0 CUFT



HK-007TS

### Offset Screwdrivers

ITEM NO.	Size	A mm	Length mm	Weight g	PCS 	G.W. KGS	CUFT 	CODE @
560610	1.0 x 6	16	125	40	180	8.5	1.60	000500
560812	1.2 x 8	20	150	75	180	14.5	1.60	000500
560916	1.6 x 9	25	175	90	180	17	1.60	000500
570012	#1 - 2	22	125	40	180	8.5	1.60	000500
570034	#3 - 4	30	175	90	180	17	1.60	000500



### OS-505SP 5 Piece Offset Screwdriver Set

Item No. Description

**Slotted Offset Screwdriver:**

- 560610 1.0 x 6mm Slotted Offset Screwdriver
- 560812 1.2 x 8mm Slotted Offset Screwdriver
- 560916 1.6 x 9mm Slotted Offset Screwdriver

**Philips Offset Screwdriver:**

- 570012 #1 - 2 Philips Offset Screwdriver
- 570034 #1 - 2 Philips Offset Screwdriver

Slide Card

750 g      CODE : 002370

20 Sets / 16 Kgs / 0.73 CUFT





OS-505SP





# Torque Wrenches

## 1/4" Dr. Torque Screwdrivers

ITEM NO.	Capacity	Length mm	Weight g	PCS 	G.W. KGS	CUFT 	CODE @
280005N	0.5 ~ 5 Nm	1-5 150	360	12	5.5	0.30	011000
280045L	8 ~ 45 in.lb.	9-45 150	360	12	5.5	0.30	011000





TO-227L  
(TO-227N)

### TO-227L 27 Piece Torque Screwdriver Set

Item No.	Description
280045L	1/4" Dr. Torque Screwdriver 8 ~ 45 in.lb.
<b>Slotted Screwdriver Bit 30mmL:</b>	
1160	1.0 x 6.0 Slotted Screwdriver Bit
1165	1.0 x 6.5 Slotted Screwdriver Bit
1170	1.2 x 7.0 Slotted Screwdriver Bit
<b>Phillips Screwdriver Bit 30mmL:</b>	
1101	#1 Phillips Screwdriver Bit
1102	#2 Phillips Screwdriver Bit
1103	#3 Phillips Screwdriver Bit
<b>Metric Hex Screwdriver Bit 30mmL:</b>	
2133	3mm Hex Screwdriver Bit
2134	4mm Hex Screwdriver Bit
2135	5mm Hex Screwdriver Bit
2136	6mm Hex Screwdriver Bit
<b>SAE Hex Screwdriver Bit 30mmL:</b>	
3108	1/8" Hex Screwdriver Bit
3110	5/32" Hex Screwdriver Bit
3112	3/16" Hex Screwdriver Bit
3114	7/32" Hex Screwdriver Bit
3116	1/4" Hex Screwdriver Bit
<b>Tamperproof Star Screwdriver Bit 30mmL:</b>	
7110	T-10 Tamperproof Star Screwdriver Bit
7115	T-15 Tamperproof Star Screwdriver Bit
7120	T-20 Tamperproof Star Screwdriver Bit
7125	T-25 Tamperproof Star Screwdriver Bit
7127	T-27 Tamperproof Star Screwdriver Bit
7130	T-30 Tamperproof Star Screwdriver Bit
7140	T-40 Tamperproof Star Screwdriver Bit
<b>Triple Square Screwdriver Bit 30mmL:</b>	
8104	M4 Triple Square Screwdriver Bit
8105	M5 Triple Square Screwdriver Bit
8106	M6 Triple Square Screwdriver Bit



**Accessory:**  
283508 1/4" Dr. 1/4" Hex Shank Bit Holder  
Blow Case

 750 g      CODE : 012420  
 25 Sets / 20 Kgs / 1.39 CUFT

### TO-227N 27 Piece Torque Screwdriver Set

Item No.	Description
280005N	1/4" Dr. Torque Screwdriver 0.5 ~ 5 Nm
<b>Slotted Screwdriver Bit 30mmL:</b>	
1160	1.0 x 6.0 Slotted Screwdriver Bit
1165	1.0 x 6.5 Slotted Screwdriver Bit
1170	1.2 x 7.0 Slotted Screwdriver Bit
<b>Phillips Screwdriver Bit 30mmL:</b>	
1101	#1 Phillips Screwdriver Bit
1102	#2 Phillips Screwdriver Bit
1103	#3 Phillips Screwdriver Bit
<b>Metric Hex Screwdriver Bit 30mmL:</b>	
2133	3mm Hex Screwdriver Bit
2134	4mm Hex Screwdriver Bit
2135	5mm Hex Screwdriver Bit
2136	6mm Hex Screwdriver Bit
<b>SAE Hex Screwdriver Bit 30mmL:</b>	
3108	1/8" Hex Screwdriver Bit
3110	5/32" Hex Screwdriver Bit
3112	3/16" Hex Screwdriver Bit
3114	7/32" Hex Screwdriver Bit
3116	1/4" Hex Screwdriver Bit
<b>Tamperproof Star Screwdriver Bit 30mmL:</b>	
7110	T-10 Tamperproof Star Screwdriver Bit
7115	T-15 Tamperproof Star Screwdriver Bit
7120	T-20 Tamperproof Star Screwdriver Bit
7125	T-25 Tamperproof Star Screwdriver Bit
7127	T-27 Tamperproof Star Screwdriver Bit
7130	T-30 Tamperproof Star Screwdriver Bit
7140	T-40 Tamperproof Star Screwdriver Bit
<b>Triple Square Screwdriver Bit 30mmL:</b>	
8104	M4 Triple Square Screwdriver Bit
8105	M5 Triple Square Screwdriver Bit
8106	M6 Triple Square Screwdriver Bit

**Accessory:**  
283508 1/4" Dr. 1/4" Hex Shank Bit Holder  
Blow Case



 750 g      CODE : 012420  
 25 Sets / 20 Kgs / 1.39 CUFT

# Torque Wrenches



## 1/4" Dr. Torque Wrenches

ITEM NO.	Capacity	Length mm	Weight g	PCS 	G.W. KGS	CUFT 	CODE @
280030N	6 ~ 30 Nm	350	740	20	20.0	1.12	010200
280250L	40 ~ 250 in.lb.	350	740	20	20.0	1.12	010200



## 3/8" Dr. Torque Wrenches

ITEM NO.	Capacity	Length mm	Weight g	PCS 	G.W. KGS	CUFT 	CODE @
380030N	6 ~ 30 Nm	350	740	20	20.0	1.12	010200
380110N	19 ~ 110 Nm	385	960	12	16.0	1.18	010400
380250L	40 ~ 250 in.lb.	350	740	20	20.0	1.12	010200
380080F	15 ~ 80 ft.lb.	385	960	12	16.0	1.18	010400



## 1/2" Dr. Torque Wrenches

ITEM NO.	Capacity	Length mm	Weight g	PCS 	G.W. KGS	CUFT 	CODE @
480210N	40 ~ 210 Nm	535	1700	10	21.0	1.31	012900
480350N	70 ~ 350 Nm	645	2540	6	19.0	0.92	016500
480150F	30 ~ 150 ft.lb.	535	1700	10	21.0	1.31	012900
480250F	50 ~ 250 ft.lb.	645	2540	6	19.0	0.92	016500



## 3/4" Dr. Torque Wrenches

ITEM NO.	Capacity	Length mm	Weight g	PCS 	G.W. KGS	CUFT 	CODE @
680500N	100 ~ 500 Nm	865	3660	4	20.0	1.07	024300
680700N	140 ~ 700 Nm	1092	5940	4	31.0	1.93	069200
680980N	140 ~ 980 Nm	1230	6460	2	17.0	1.13	086500
680300F	50 ~ 300 ft.lb.	865	3660	4	20.0	1.07	024300
680600F	100 ~ 600 ft.lb.	1092	5940	4	31.0	1.93	069200
680700F	100 ~ 700 ft.lb.	1230	6460	2	17.0	1.13	086500

## 1" Dr. Torque Wrenches

ITEM NO.	Capacity	Length mm	Weight g	PCS 	G.W. KGS	CUFT 	CODE @
880980N	140 ~ 980 Nm	1230	6460	2	17.0	1.13	086500
880700F	100 ~ 700 ft.lb.	1230	6460	2	17.0	1.13	086500

## Torque Multipliers



ITEM NO.	Drive Inch	Capacity	Length mm	Weight g	PCS 	G.W. KGS	CUFT 	CODE @
401000	Input: 1/2" Output: 3/4"	MAX: 460 Nm/340 ft.lb. MAX: 1400 Nm/1000 ft.lb. Output/Input = 3/1	420	2330	6	15.0	1.37	048500
602000	Input: 3/4" Output: 1"	MAX: 900 Nm/650 ft.lb. MAX: 2700 Nm/2000 ft.lb. Output/Input = 3/1	500	4750	4	20.0	1.4	053600

- The desired torque is set before using the torque wrenches.
- When torque is applied, a click can be heard and felt when the desired torque is reached. This feature is more evident in the higher range of the scale.
- Graduated scales in SAE and Metric measurement systems are etched on the shaft. They are horizontal on the shaft and vertical on the handle.
- Continuous-use design offers the user an excellent precision tool for specific torques.
- All parts are made of steel and tempered to prevent wear. Outer parts have a nickel-chromium coating to prevent oxidation.
- The lever on the ratchet head can be positioned for ratchet action to the left, to the right, or fixed.
- Double armature: exclusive internal design minimizes the amount of force required, reduces friction, lengthens tool life and permits precise, long-lasting calibration.
- Meets or exceeds the requirements of ANSI & DIN standards with accuracy of  $\pm 4\%$  to the right and  $\pm 6\%$  to the left





# Pipe Wrenches

## Heavy Duty Pipe Wrenches

ITEM NO.	Length Inch	Weight g	PCS 	G.W. KGS	CUFT 	CODE @
782200	8	470	36	18.0	0.40	001360
782250	10	840	24	21.0	0.50	001950
782300	12	1100	24	27.0	0.70	002200
782350	14	1420	12	18.0	0.50	002610
782460	18	2440	8	20.5	0.60	003870
782610	24	4330	6	27.0	0.80	006060
782910	36	8000	2	17.0	0.80	012320
783220	48	14000	2	29.0	1.30	025060

## Aluminum Pipe Wrenches

ITEM NO.	Length Inch	Weight g	PCS 	G.W. KGS	CUFT 	CODE @
784350	14	880	24	22.0	0.70	003760
784460	18	1460	12	18.5	0.70	005640
784610	24	2440	8	20.5	0.80	008770
784910	36	4500	4	19.0	1.10	016290
785220	48	8000	2	17.0	1.20	028200

