

# COUPLINGS AND CLUTCHES

## Table of Contents

COUPLINGS	
Six Beam Flexible . . . . .	MG 2 - MG 7
Three Beam Flexible . . . . .	MG 8 - MG 11
Single Beam Flexible . . . . .	MG 12 - MG 13
Reli-A-Flex ® . . . . .	MG 14 - MG 17
Flex-Thane Couplings . . . . .	MG 18
Absorbathane Flexible . . . . .	MG 19
Neo-Flex . . . . .	MG 20 - MG 21
Sleeve . . . . .	MG 22
Spider . . . . .	MG 23 - MG 24
Multi-Jaw . . . . .	MG 25
Bellows . . . . .	MG 26
Oldham . . . . .	MG 27 - MG 28
Universal Lateral . . . . .	MG 29 - MG 30
Wafer Spring . . . . .	MG 31 - MG 32
UNIVERSAL JOINTS . . . . .	MG 33 - MG 34
TELESCOPIC UNIVERSAL JOINTS . . . . .	MG 35
SHAFT ADAPTERS	
Clamp Style . . . . .	MG 36
SLIP COUPLINGS . . . . .	MG 37 - MG 39
OVERRUNNING COUPLING . . . . .	MG 40
INLINE COUPLING SLIP CLUTCH . . . . .	MG 41
SLIP CLUTCH . . . . .	MG 42 - MG 45
MINIATURE SLIP CLUTCH . . . . .	MG 46
SLIP CLUTCHES AND COUPLINGS . . . . .	MG 47
ROLLER CLUTCHES . . . . .	MG 48

*For inch options, please see our inch catalog.*

# SIX BEAM FLEXIBLE COUPLING

BORES	STYLE	MATERIAL
2MM TO 30MM	SET SCREW	ANODIZED ALUMINUM

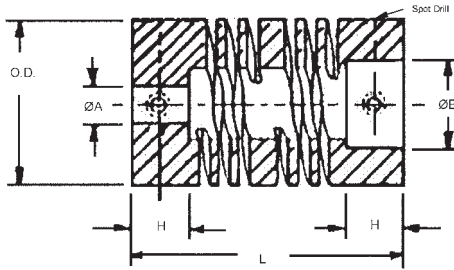

STOCK NO.	ØA +0.05 -0.00	ØB +0.05 -0.00	ØO.D.	L	H	ANGLE OFF SET	PARALLEL OFF SET	MAX. WORKING TORQUE (N*cm)
CO36A-1M CO36A-2M CO36A-3M CO36A-4M	2.00 3.00 3.00 4.00	3.00 3.00 4.00 4.00	9.5	19.6	6.0	5°	0.1	55
CO38A-1M CO38A-2M CO38A-3M CO38A-4M	3.00 3.00 5.00 6.00	3.00 5.00 5.00 6.00	12.7	25.4	6.9	5°	0.2	110
CO40A-1M CO40A-2M CO40A-3M CO40A-4M	5.00 6.00 6.00 10.00	6.00 6.00 10.00 10.00	19.1	28.0	6.4	7°	0.3	280
CO42A-1M CO42A-2M CO42A-3M CO42A-4M	6.00 8.00 10.00 13.00	6.00 8.00 10.00 13.00	25.4	38.7	11.7	7°	0.4	490
CO44A-1M CO44A-2M CO44A-3M CO44A-4M	6.00 10.00 13.00 16.00	10.00 10.00 13.00 16.00	31.7	57.2	16.0	7°	0.5	680
CO50A-1M CO50A-2M CO50A-3M	10.00 12.00 16.00	12.00 12.00 16.00	38.1	66.7	18.0	7°	0.6	900
CO52A-1M CO52A-2M CO52A-3M	14.00 16.00 20.00	14.00 16.00 20.00	44.5	76.2	20.0	7°	0.8	1000
CO54A-1M CO54A-2M CO54A-3M	20.00 25.00 30.00	20.00 25.00 30.00	57.2	130.0	32.0	7°	0.9	2200

Operating temperature -40° C to 120°C

## Advantages

- One Piece construction. no mechanical joints
- No Backlash
- Constant velocity
- Torsionally rigid
- High Flexibility
- Small and lightweight
- High or low speeds
- Not temperature sensitive
- No lubrication
- Unaffected by climactic conditions
- Reversible

## Applications

Encoders • Stepper Motors • Precision Ball Screws • Machine Tools • Robotics • Scientific Equipment  
 • Measuring Instruments • Computers • Servo Systems • Optical Telescopes • Defense Systems  
 • Medical Equipment • Appliances • Pumps • Valves • Fans

Central relief diameter may be smaller than bore in some cases.

# SIX BEAM FLEXIBLE COUPLING

BORES	STYLE	MATERIAL
2MM TO 30MM	SET SCREW	STAINLESS STEEL DIN 1.4305

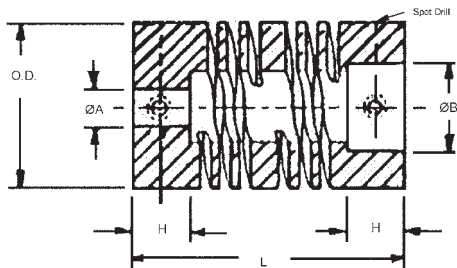

STOCK NO.	ØA +0.05 -0.00	ØB +0.05 -0.00	ØO.D.	L	H	ANGLE OFF SET	PARALLEL OFF SET	MAX. WORKING TORQUE (N*cm)
CO36S-1M	2.00	3.00	9.5	19.6	6.0	5°	0.1	85
CO36S-2M	3.00	3.00						
CO36S-3M	3.00	4.00						
CO36S-4M	4.00	4.00						
CO38S-1M	3.00	3.00	12.7	25.4	6.9	5°	0.2	150
CO38S-2M	3.00	5.00						
CO38S-3M	5.00	5.00						
CO38S-4M	6.00	6.00						
CO40S-1M	5.00	6.00	19.1	28.0	6.4	7°	0.3	400
CO40S-2M	6.00	6.00						
CO40S-3M	6.00	10.00						
CO40S-4M	10.00	10.00						
CO42S-1M	6.00	6.00	25.4	38.7	11.7	7°	0.4	900
CO42S-2M	8.00	8.00						
CO42S-3M	10.00	10.00						
CO42S-4M	13.00	13.00						
CO44S-1M	6.00	10.00	31.7	57.2	16.0	7°	0.5	1000
CO44S-2M	10.00	10.00						
CO44S-3M	13.00	13.00						
CO44S-4M	16.00	16.00						
CO50S-1M	10.00	12.00	38.1	66.7	18.0	7°	0.6	1500
CO50S-2M	12.00	12.00						
CO50S-3M	16.00	16.00						
CO52S-1M	14.00	14.00	44.5	76.2	20.0	7°	0.8	1900
CO52S-2M	16.00	16.00						
CO52S-3M	20.00	20.00						
CO54S-1M	20.00	20.00	57.2	130.0	32.0	7°	0.9	4100
CO54S-2M	25.00	25.00						
CO54S-3M	30.00	30.00						

Operating temperature -40° C to 120°C

## Advantages

- One Piece construction. no mechanical joints
- No Backlash
- Constant velocity
- Torsionally rigid
- High Flexibility
- Small and lightweight
- High or low speeds
- Not temperature sensitive
- No lubrication
- Unaffected by climactic conditions
- Reversible

## Applications

Encoders • Stepper Motors • Precision Ball Screws • Machine Tools • Robotics • Scientific Equipment  
 • Measuring Instruments • Computers • Servo Systems • Optical Telescopes • Defense Systems  
 • Medical Equipment • Appliances • Pumps • Valves • Fans

Central relief diameter may be smaller than bore in some cases.

# SIX BEAM FLEXIBLE COUPLING

BORES	STYLE	MATERIAL
2MM TO 30MM	SET SCREW	DELRIN

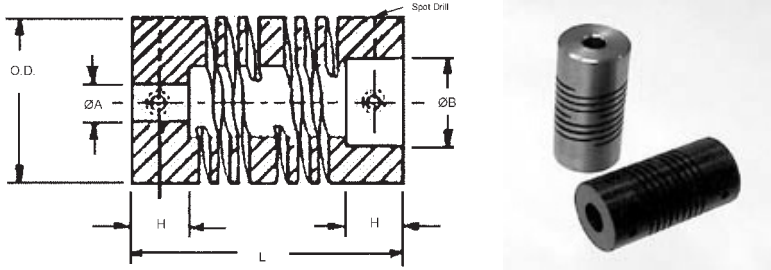

STOCK NO.	ØA +0.05 -0.00	ØB +0.05 -0.00	ØO.D.	L	H	ANGLE OFF SET	PARALLEL OFF SET	MAX. WORKING TORQUE (N*cm)
CO38D-1M CO38D-2M CO38D-3M CO38D-4M	3.00 3.00 5.00 6.00	3.00 5.00 5.00 6.00	12.7	25.4	6.9	5°	0.2	25
CO40D-1M CO40D-2M CO40D-3M CO40D-4M	5.00 6.00 6.00 10.00	6.00 6.00 10.00 10.00	19.1	28.0	6.4	7°	0.3	80
CO42D-1M CO42D-2M CO42D-3M CO42D-4M	6.00 8.00 10.00 13.00	6.00 8.00 10.00 13.00	25.4	38.7	11.7	7°	0.4	150
CO44D-1M CO44D-2M CO44D-3M CO44D-4M	6.00 10.00 13.00 16.00	10.00 10.00 13.00 16.00	31.7	57.2	16.0	7°	0.5	230
CO50D-1M CO50D-2M CO50D-3M	10.00 12.00 16.00	12.00 12.00 16.00	38.1	66.7	18.0	7°	0.6	275
CO52D-1M CO52D-2M CO52D-3M	14.00 16.00 20.00	14.00 16.00 20.00	44.5	76.2	20.0	7°	0.8	325
CO54D-1M CO54D-2M CO54D-3M	20.00 25.00 30.00	20.00 25.00 30.00	57.2	130.0	32.0	7°	0.9	380

Operating temperature -20° C to 60° C

## Advantages

- One Piece construction. no mechanical joints
- No Backlash
- Constant velocity
- Torsionally rigid
- High Flexibility
- Small and lightweight
- High or low speeds
- Not temperature sensitive
- No lubrication
- Unaffected by climactic conditions
- Reversible

## Applications

Encoders • Stepper Motors • Precision Ball Screws • Machine Tools • Robotics • Scientific Equipment  
 • Measuring Instruments • Computers • Servo Systems • Optical Telescopes • Defense Systems  
 • Medical Equipment • Appliances • Pumps • Valves • Fans

NOTE: Maximum angular offset of 10°.

Central relief diameter may be smaller than bore in some cases.

# SIX BEAM FLEXIBLE COUPLING

BORES	STYLE	MATERIAL
2MM TO 30MM	CLAMP	ANODIZED ALUMINUM

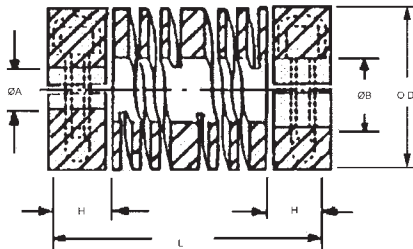

STOCK NO.	ØA +0.05 -0.00	ØB +0.05 -0.00	ØO.D.	L	H	ANGLE OFF SET	PARALLEL OFF SET	MAX. WORKING TORQUE (N*cm)
CO37A-1M CO37A-2M CO37A-3M CO37A-4M	2.00 3.00 3.00 4.00	3.00 3.00 4.00 4.00	9.5	19.6	6.0	5°	0.1	55
CO39A-1M CO39A-2M CO39A-3M CO39A-4M	3.00 3.00 5.00 6.00	3.00 5.00 5.00 6.00	12.7	25.4	6.9	5°	0.2	110
CO41A-1M CO41A-2M CO41A-3M CO41A-4M	5.00 6.00 6.00 10.00	6.00 6.00 10.00 10.00	19.1	28.0	6.4	7°	0.3	280
CO43A-1M CO43A-2M CO43A-3M CO43A-4M	6.00 8.00 10.00 13.00	6.00 8.00 10.00 13.00	25.4	38.7	11.7	7°	0.4	490
CO45A-1M CO45A-2M CO45A-3M CO45A-4M	6.00 10.00 13.00 16.00	10.00 10.00 13.00 16.00	31.7	57.2	16.0	7°	0.5	680
CO51A-1M CO51A-2M CO51A-3M	10.00 12.00 16.00	12.00 12.00 16.00	38.1	66.7	18.0	7°	0.6	900
CO53A-1M CO53A-2M CO53A-3M	14.00 16.00 20.00	14.00 16.00 20.00	44.5	76.2	20.0	7°	0.8	1000
CO55A-1M CO55A-2M CO55A-3M	20.00 25.00 30.00	20.00 25.00 30.00	57.2	130.0	32.0	7°	0.9	2200

Operating temperature -40° C to 120°C

## Advantages

- One Piece construction. no mechanical joints
- No Backlash
- Constant velocity
- Torsionally rigid
- High Flexibility
- Small and lightweight
- High or low speeds
- Not temperature sensitive
- No lubrication
- Unaffected by climactic conditions
- Reversible

## Applications

Encoders • Stepper Motors • Precision Ball Screws • Machine Tools • Robotics • Scientific Equipment  
 • Measuring Instruments • Computers • Servo Systems • Optical Telescopes • Defense Systems  
 • Medical Equipment • Appliances • Pumps • Valves • Fans

Central relief diameter may be smaller than bore in some cases.

# SIX BEAM FLEXIBLE COUPLING

BORES	STYLE	MATERIAL
2MM TO 30MM	CLAMP	STAINLESS STEEL DIN 1.4305

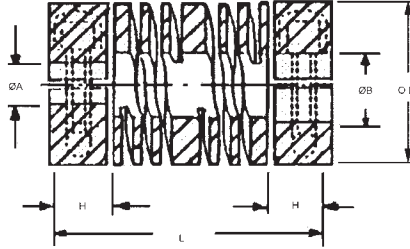

STOCK NO.	$\varnothing A$ +0.05 -0.00	$\varnothing B$ +0.05 -0.00	$\varnothing O.D.$	L	H	ANGLE OFF SET	PARALLEL OFF SET	MAX. WORKING TORQUE (N*cm)
CO37S-1M CO37S-2M CO37S-3M CO37S-4M	2.00 3.00 3.00 4.00	3.00 3.00 4.00 4.00	9.5	19.6	6.0	5°	0.1	85
CO39S-1M CO39S-2M CO39S-3M CO39S-4M	3.00 3.00 5.00 6.00	3.00 5.00 5.00 6.00	12.7	25.4	6.9	5°	0.2	150
CO41S-1M CO41S-2M CO41S-3M CO41S-4M	5.00 6.00 6.00 10.00	6.00 6.00 10.00 10.00	19.1	28.0	6.4	7°	0.3	400
CO43S-1M CO43S-2M CO43S-3M CO43S-4M	6.00 8.00 10.00 13.00	6.00 8.00 10.00 13.00	25.4	38.7	11.7	7°	0.4	900
CO45S-1M CO45S-2M CO45S-3M CO45S-4M	6.00 10.00 13.00 16.00	10.00 10.00 13.00 16.00	31.7	57.2	16.0	7°	0.5	1000
CO51S-1M CO51S-2M CO51S-3M	10.00 12.00 16.00	12.00 12.00 16.00	38.1	66.7	18.0	7°	0.6	1500
CO53S-1M CO53S-2M CO53S-3M	14.00 16.00 20.00	14.00 16.00 20.00	44.5	76.2	20.0	7°	0.8	1900
CO55S-1M CO55S-2M CO55S-3M	20.00 25.00 30.00	20.00 25.00 30.00	57.2	130.0	32.0	7°	0.9	4100

Operating temperature -40° C to 120°C

## Advantages

- One Piece construction. no mechanical joints
- No Backlash
- Constant velocity
- Torsionally rigid
- High Flexibility
- Small and lightweight
- High or low speeds
- Not temperature sensitive
- No lubrication
- Unaffected by climactic conditions
- Reversible

## Applications

Encoders • Stepper Motors • Precision Ball Screws • Machine Tools • Robotics • Scientific Equipment  
 • Measuring Instruments • Computers • Servo Systems • Optical Telescopes • Defense Systems  
 • Medical Equipment • Appliances • Pumps • Valves • Fans

Central relief diameter may be smaller than bore in some cases.

# SIX BEAM FLEXIBLE COUPLING

BORES	STYLE	MATERIAL
3MM TO 30MM	CLAMP	DELTRIN

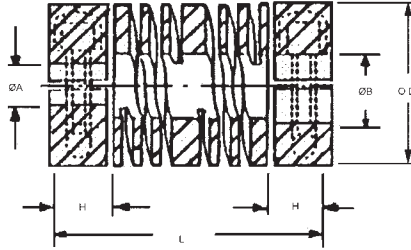

STOCK NO.	ØA +0.05 -0.00	ØB +0.05 -0.00	ØO.D.	L	H	ANGLE OFF SET	PARALLEL OFF SET	MAX. WORKING TORQUE (N*cm)
CO39D-1M	3.00	3.00	12.7	25.4	6.9	5°	0.2	25
CO39D-2M	3.00	5.00						
CO39D-3M	5.00	5.00						
CO39D-4M	6.00	6.00						
CO41D-1M	5.00	6.00	19.1	28.0	6.4	7°	0.3	80
CO41D-2M	6.00	6.00						
CO41D-3M	6.00	10.00						
CO41D-4M	10.00	10.00						
CO43D-1M	6.00	6.00	25.4	38.7	11.7	7°	0.4	150
CO43D-2M	8.00	8.00						
CO43D-3M	10.00	10.00						
CO43D-4M	13.00	13.00						
CO45D-1M	6.00	10.00	31.7	57.2	16.0	7°	0.5	230
CO45D-2M	10.00	10.00						
CO45D-3M	13.00	13.00						
CO45D-4M	16.00	16.00						
CO51D-1M	10.00	12.00	38.1	66.7	18.0	7°	0.6	275
CO51D-2M	12.00	12.00						
CO51D-3M	16.00	16.00						
CO53D-1M	14.00	14.00	44.5	76.2	20.0	7°	0.8	325
CO53D-2M	16.00	16.00						
CO53D-3M	20.00	20.00						
CO55D-1M	20.00	20.00	57.2	130.0	32.0	7°	0.9	380
CO55D-2M	25.00	25.00						
CO55D-3M	30.00	30.00						

Operating temperature -20° C to 60°C

## Advantages

- One Piece construction. no mechanical joints
- No Backlash
- Constant velocity
- Torsionally rigid
- High Flexibility
- Small and lightweight
- High or low speeds
- Not temperature sensitive
- No lubrication
- Unaffected by climactic conditions
- Reversible

## Applications

Encoders • Stepper Motors • Precision Ball Screws • Machine Tools • Robotics • Scientific Equipment  
 • Measuring Instruments • Computers • Servo Systems • Optical Telescopes • Defense Systems  
 • Medical Equipment • Appliances • Pumps • Valves • Fans

NOTE: Maximum angular offset of 10°.

Central relief diameter may be smaller than bore in some cases.

# THREE BEAM FLEXIBLE COUPLING

BORE	STYLE	MATERIAL
3MM TO 12MM	SET SCREW	ALUMINUM ANODIZED

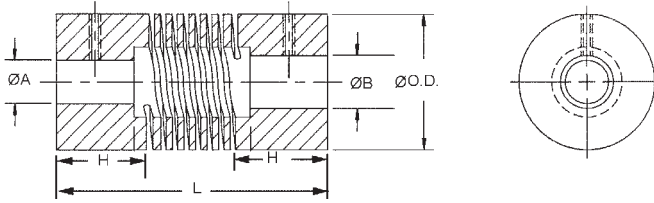

- Couplings can be supplied with a keyway
- Non-standard bore sizes available
- **Operating temperature -40° C to 120° C**

STOCK NO.	ØA +0.05 -0.00	ØB +0.05 -0.00	ØO.D.	L	H	ALLOWABLE MISALIGNMENT		
						MAX TOR. N•cm	ANGLE OFF SET	PARA OFF SET
CO71A-1M	3.00	3.00	9.5	14.2	2.8	40	5°	0.10
CO73A-1M CO73A-2M CO73A-3M CO73A-4M	3.00 4.00 4.00 5.00	3.00 4.00 5.00 5.00	12.7	19.0	5.3	90	5°	0.13
CO75A-1M CO75A-2M CO75A-3M CO75A-4M CO75A-5M	3.00 3.00 4.00 4.00 5.00	3.00 4.00 4.00 5.00 5.00	16.0	20.3	6.1	145	5°	0.13
CO77A-1M CO77A-2M CO77A-3M CO77A-4M CO77A-5M	4.00 4.00 5.00 5.00 6.00	4.00 5.00 5.00 6.00 6.00	19.0	22.9	7.1	245	5°	0.13
CO79A-1M CO79A-2M CO79A-3M CO79A-4M CO79A-5M	6.00 6.00 8.00 8.00 10.00	6.00 8.00 8.00 10.00 10.00	25.4	31.8	8.4	390	5°	0.13
CO81A-1M CO81A-2M CO81A-3M	10.00 10.00 12.00	10.00 12.00 12.00	31.8	44.5	11.2	590	5°	0.13

Central relief diameter may be smaller than bore in some cases.



# THREE BEAM FLEXIBLE COUPLING

BORE	STYLE	MATERIAL
3MM TO 12MM	SET SCREW	STAINLESS STEEL DIN 1.4305

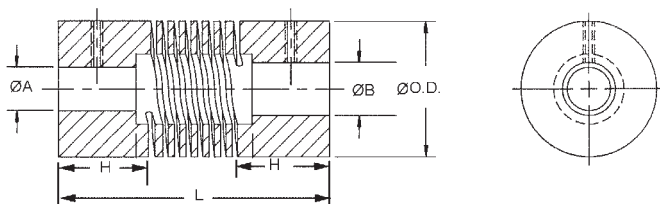

- Couplings can be supplied with a keyway
- Non-standard bore sizes available
- **Operating temperature -40° C to 120° C**

STOCK NO.	ØA +0.05 -0.00	ØB +0.05 -0.00	ØO.D.	L	H	ALLOWABLE MISALIGNMENT		
						MAX TOR. N•cm	ANGLE OFF SET	PARA OFF SET
CO71S-1M	3.00	3.00	9.5	14.2	2.8	40	5°	0.10
CO73S-1M	3.00	3.00	12.7	19.0	5.3	90	5°	0.13
CO73S-2M	4.00	4.00						
CO73S-3M	4.00	5.00						
CO73S-4M	5.00	5.00						
CO75S-1M	3.00	3.00	16.0	20.3	6.1	150	5°	0.13
CO75S-2M	3.00	4.00						
CO75S-3M	4.00	4.00						
CO75S-4M	4.00	5.00						
CO75S-5M	5.00	5.00						
CO77S-1M	4.00	4.00	19.0	22.9	7.1	250	5°	0.13
CO77S-2M	4.00	5.00						
CO77S-3M	5.00	5.00						
CO77S-4M	5.00	6.00						
CO77S-5M	6.00	6.00						
CO79S-1M	6.00	6.00	25.4	31.8	8.4	550	5°	0.13
CO79S-2M	6.00	8.00						
CO79S-3M	8.00	8.00						
CO79S-4M	8.00	10.00						
CO79S-5M	10.00	10.00						
CO81S-1M	10.00	10.00	31.8	44.5	11.2	950	5°	0.13
CO81S-2M	10.00	12.00						
CO81S-3M	12.00	12.00						

Central relief diameter may be smaller than bore in some cases.

G

# THREE BEAM FLEXIBLE COUPLING

BORE	STYLE	MATERIAL
3MM TO 12MM	CLAMP	ALUMINUM ANODIZED

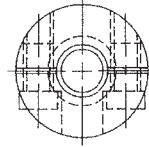
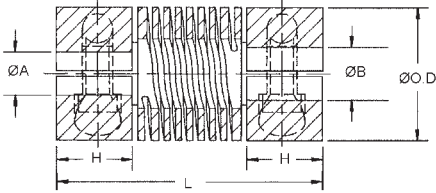

- Couplings can be supplied with a keyway
- Non-standard bore sizes available
- Operating temperature **-40° C to 120°C**

STOCK NO.	ØA +0.05 -0.00	ØB +0.05 -0.00	ØO.D.	L	H	ALLOWABLE MISALIGNMENT		
						MAX TOR. N•cm	ANGLE OFF SET	PARA OFF SET
CO72A-1M CO72A-2M CO72A-3M CO72A-4M	3.00 4.00 4.00 5.00	3.00 4.00 5.00 5.00	12.7	19.0	5.3	90	5°	0.13
CO74A-1M CO74A-2M CO74A-3M CO74A-4M CO74A-5M	3.00 3.00 4.00 4.00 5.00	3.00 4.00 4.00 5.00 5.00	16.0	20.3	6.1	145	5°	0.13
CO76A-1M CO76A-2M CO76A-3M CO76A-4M CO76A-5M	4.00 4.00 5.00 5.00 6.00	4.00 5.00 5.00 6.00 6.00	19.0	22.9	7.1	245	5°	0.13
CO78A-1M CO78A-2M CO78A-3M CO78A-4M CO78A-5M	6.00 6.00 8.00 8.00 10.00	6.00 8.00 8.00 10.00 10.00	25.4	31.8	8.4	390	5°	0.13
CO80A-1M CO80A-2M CO80A-3M	10.00 10.00 12.00	10.00 12.00 12.00	31.8	44.5	11.2	590	5°	0.13

Central relief diameter may be smaller than bore in some cases.

# THREE BEAM FLEXIBLE COUPLING

BORE	STYLE	MATERIAL
3MM TO 12MM	CLAMP HUB	STAINLESS STEEL 1.4305

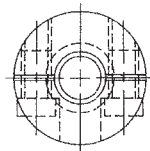
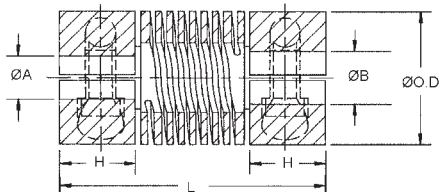

- Couplings can be supplied with a keyway
- Non-standard bore sizes available
- All couplings contain an integral relief chamber
- **Operating temperature -40° C to 120°C**

STOCK NO.	ØA +0.05 -0.00	ØB +0.05 -0.00	ØO.D.	L	H	ALLOWABLE MISALIGNMENT		
						MAX TOR. N*cm	ANGLE OFF SET	PARA OFF SET
CO72S-1M CO72S-2M CO72S-3M CO72S-4M	3.00 4.00 4.00 5.00	3.00 4.00 5.00 5.00	12.7	19.0	5.3	90	5°	0.13
CO74S-1M CO74S-2M CO74S-3M CO74S-4M CO74S-5M	3.00 3.00 4.00 4.00 5.00	3.00 4.00 4.00 5.00 5.00	16.0	20.3	6.1	150	5°	0.13
CO76S-1M CO76S-2M CO76S-3M CO76S-4M CO76S-5M	4.00 4.00 5.00 5.00 6.00	4.00 5.00 5.00 6.00 6.00	19.0	22.9	7.1	250	5°	0.13
CO78S-1M CO78S-2M CO78S-3M CO78S-4M CO78S-5M	6.00 6.00 8.00 8.00 10.00	6.00 8.00 8.00 10.00 10.00	25.4	31.8	8.4	550	5°	0.13
CO80S-1M CO80S-2M CO80S-3M	10.00 10.00 12.00	10.00 12.00 12.00	31.8	44.5	11.2	950	5°	0.13

Central relief diameter may be smaller than bore in some cases.

# SINGLE BEAM FLEXIBLE COUPLING

BORES	STYLE	MATERIAL
3MM TO 25MM	SET SCREW	ALUMINUM ANODIZED

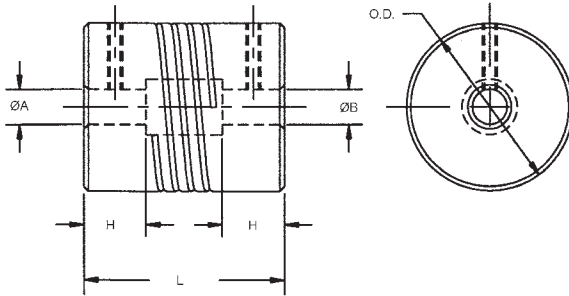

STOCK NO.	ØA +0.05 -0.00	ØB +0.05 -0.00	ØO.D.	L	H	MAX. WORKING TORQUE (N*cm)	ANGULAR OFFSET	PARALLEL OFFSET
COS71A-1M	3.00	3.00	9.5	14.2	2.8	15	5°	0.13
COS73A-1M	3.00	3.00	12.7	19.0	5.3	45	5°	0.25
COS73A-2M	4.00	4.00						
COS73A-3M	4.00	4.00						
COS73A-4M	5.00	5.00						
COS75A-1M	3.00	3.00	16.0	20.3	6.1	65	5°	0.25
COS75A-2M	3.00	3.00						
COS75A-3M	4.00	4.00						
COS75A-4M	4.00	4.00						
COS75A-5M	5.00	5.00						
COS77A-1M	4.00	4.00	19.1	22.9	7.1	115	5°	0.25
COS77A-2M	4.00	4.00						
COS77A-3M	5.00	5.00						
COS77A-4M	5.00	5.00						
COS77A-5M	6.00	6.00						
COS79A-1M	6.00	6.00	25.5	31.8	8.4	165	5°	0.25
COS79A-2M	6.00	8.00						
COS79A-3M	8.00	8.00						
COS79A-4M	8.00	10.00						
COS79A-5M	10.00	10.00						
COS81A-1M	10.00	10.00	31.8	44.5	11.2	345	5°	0.25
COS81A-2M	10.00	12.00						
COS81A-3M	12.00	12.00						
COS83A-1M	12.00	12.00	38.0	67.0	18.0	500	5°	0.25
COS83A-2M	16.00	16.00						
COS83A-3M	19.00	19.00						
COS85A-1M	12.00	12.00	44.5	76.2	20.0	675	5°	0.25
COS85A-2M	16.00	16.00						
COS85A-3M	19.00	19.00						
COS87A-1M	19.00	19.00	57.0	130.3	32.0	1100	5°	0.25
COS87A-2M	22.00	22.00						
COS87A-3M	25.00	25.00						

Central relief diameter may be smaller than bore in some cases.

# SINGLE BEAM FLEXIBLE COUPLING

BORE	STYLE	MATERIAL
3MM TO 25MM	CLAMP	ALUMINUM ANODIZED

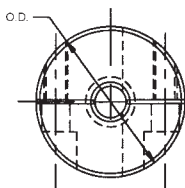
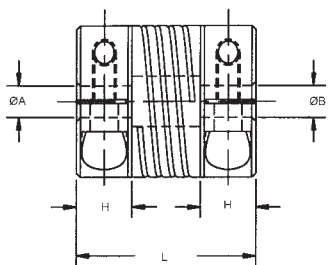

STOCK NO.	$\varnothing A$ +0.05	$\varnothing B$ +0.05	$\varnothing O.D.$	L	H	MAX WORKING TORQUE (N*cm)	ANGULAR OFF SET	PARALLEL OFF SET
COS72A-1M	3.00	3.00	12.7	19.0	5.3	45	5°	0.25
COS72A-2M	4.00	4.00						
COS72A-3M	4.00	4.00						
COS72A-4M	5.00	5.00						
COS74A-1M	3.00	3.00	16.0	20.3	6.1	68	5°	0.25
COS74A-2M	3.00	3.00						
COS74A-3M	4.00	4.00						
COS74A-4M	4.00	4.00						
COS74A-5M	5.00	5.00						
COS76A-1M	4.00	4.00	19.1	22.9	7.1	118	5°	0.25
COS76A-2M	4.00	4.00						
COS76A-3M	5.00	5.00						
COS76A-4M	5.00	5.00						
COS76A-5M	6.00	6.00						
COS78A-1M	6.00	6.00	25.5	31.8	8.4	170	5°	0.25
COS78A-2M	6.00	8.00						
COS78A-3M	8.00	8.00						
COS78A-4M	8.00	10.00						
COS78A-5M	10.00	10.00						
COS80A-1M	10.00	10.00	31.8	44.5	11.2	350	5°	0.25
COS80A-2M	10.00	12.00						
COS80A-3M	12.00	12.00						
COS82A-1M	12.00	12.00	38.0	67.0	18.0	508	5°	0.25
COS82A-2M	16.00	16.00						
COS82A-3M	19.00	19.00						
COS84A-1M	12.00	12.00	44.5	76.2	20.0	678	5°	0.25
COS84A-2M	16.00	16.00						
COS84A-3M	19.00	19.00						
COS86A-1M	19.00	19.00	57.0	130.3	32.0	1130	5°	0.25
COS86A-2M	22.00	22.00						
COS86A-3M	25.00	25.00						

Central relief diameter may be smaller than bore in some cases.

G

# RELI-A-FLEX COUPLINGS

BORES	STYLE	MATERIAL
3MM TO 12MM	CLAMP, SHORT	ALUMINUM 7075 ALOCROM FINISH

STOCK NO.	L	ØD	ØB1 +.05 -.00	ØB2 +.05 -.00	E	SOCKET SCREW SIZE	ØH
RCSA13C-1M	13	16.80	3.0	3.0	5.0	M1.6	14.5
RCSA13C-2M	13	16.80	3.0	4.0	5.0	M1.6	14.5
RCSA13C-3M	13	16.80	4.0	4.0	5.0	M1.6	14.5
RCSA13C-4M	13	16.80	4.0	5.0	5.0	M1.6	14.5
RCSA13C-5M	13	16.80	5.0	5.0	5.0	M1.6	14.5
RCSA13C-6M	13	16.80	5.0	6.0	5.0	M1.6	14.5
RCSA13C-7M	13	16.80	6.0	6.0	5.0	M1.6	14.5
RCSA16C-1M	16	19.75	3.0	3.0	5.90	M2	18.0
RCSA16C-2M	16	19.75	3.0	4.0	5.90	M2	18.0
RCSA16C-3M	16	19.75	4.0	4.0	5.90	M2	18.0
RCSA16C-4M	16	19.75	4.0	5.0	5.90	M2	18.0
RCSA16C-5M	16	19.75	5.0	5.0	5.90	M2	18.0
RCSA16C-6M	16	19.75	5.0	6.0	5.90	M2	18.0
RCSA16C-7M	16	19.75	6.0	6.0	5.90	M2	18.0
RCSA16C-8M	16	19.75	6.0	8.0	5.90	M2	18.0
RCSA16C-9M	16	19.75	8.0	8.0	5.90	M2	18.0
RCSA20C-1M	20	21.50	4.0	4.0	6.60	M3	21.8
RCSA20C-2M	20	21.50	4.0	5.0	6.60	M3	21.8
RCSA20C-3M	20	21.50	5.0	5.0	6.60	M3	21.8
RCSA20C-4M	20	21.50	5.0	6.0	6.60	M3	21.8
RCSA20C-5M	20	21.50	6.0	6.0	6.60	M3	21.8
RCSA20C-6M	20	21.50	6.0	8.0	6.60	M3	21.8
RCSA20C-7M	20	21.50	8.0	8.0	6.60	M3	21.8
RCSA20C-8M	20	21.50	8.0	10.0	6.60	M3	21.8
RCSA20C-9M	20	21.50	10.0	10.0	6.60	M3	21.8
RCSA25C-1M	25	25.80	5.0	5.0	7.60	M3	26.9
RCSA25C-2M	25	25.80	5.0	6.0	7.60	M3	26.9
RCSA25C-3M	25	25.80	6.0	6.0	7.60	M3	26.9
RCSA25C-4M	25	25.80	6.0	8.0	7.60	M3	26.9
RCSA25C-5M	25	25.80	8.0	8.0	7.60	M3	26.9
RCSA25C-6M	25	25.80	8.0	10.0	7.60	M3	26.9
RCSA25C-7M	25	25.80	10.0	10.0	7.60	M3	26.9
RCSA25C-8M	25	25.80	10.0	12.0	7.60	M3	26.9
RCSA25C-9M	25	25.80	12.0	12.0	7.60	M3	26.9

## TECHNICAL FEATURES

- Zero backlash, reliable one-piece construction
- Unique design maximizes torsional stiffness without including high bearing loads
- Minimal velocity and positional fluctuations
- Over 50,000,000 test cycles at test load and 80% offset without failure
- Maintenance free
- Recommended temperature range -80°C to +80°C

## TECHNICAL SPECIFICATIONS

SIZE	TORSIONAL STIFFNESS mNm/arcmin	RADIAL COMPLIANCE microns/N	MISALIGNMENT			MAX. INERTIA g.cm <sup>2</sup>	MAX. MASS g	TYPICAL TORQUE CAPACITY			MAX. SPEED RPM
			PARALLEL MM	ANGULAR DEG.	AXIAL MM			REVERSING Nm	NONREV. Nm	PEAK Nm	
13C	13.09	29.2	0.08	2.5	±0.30	1.0	4.4	0.35	0.45	0.50	12000
16C	20.36	28.9	0.10	2.5	±0.40	2.9	8.6	0.55	0.85	1.25	10000
20C	33.45	23.4	0.12	3.0	±0.50	7.9	14.9	0.95	1.45	2.45	7500
25C	52.94	20.0	0.16	3.0	±0.70	23.0	27.5	1.55	2.35	3.90	5000

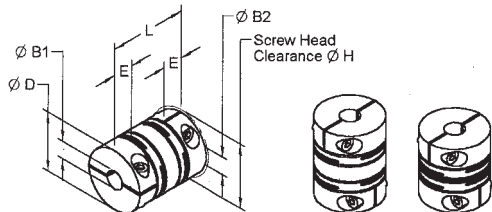

# RELI-A-FLEX COUPLINGS

BORES	STYLE	MATERIAL
3MM TO 12MM	CLAMP, LONG	ALUMINUM 7075 ALOCROM FINISH

STOCK NO.	ØD	L	ØB1 +0.05 -0.00	ØB2 +0.05 -0.00	E	SOCKET SCREW SIZE	ØH
RCLA13C-1M	13	20.0	3.0	3.0	5.0	M1.6	14.5
RCLA13C-2M	13	20.0	3.0	4.0	5.0	M1.6	14.5
RCLA13C-3M	13	20.0	4.0	4.0	5.0	M1.6	14.5
RCLA13C-4M	13	20.0	4.0	5.0	5.0	M1.6	14.5
RCLA13C-5M	13	20.0	5.0	5.0	5.0	M1.6	14.5
RCLA13C-6M	13	20.0	5.0	6.0	5.0	M1.6	14.5
RCLA13C-7M	13	20.0	6.0	6.0	5.0	M1.6	14.5
RCLA16C-1M	16	23.5	3.0	3.0	5.90	M2	18.0
RCLA16C-2M	16	23.5	3.0	4.0	5.90	M2	18.0
RCLA16C-3M	16	23.5	4.0	4.0	5.90	M2	18.0
RCLA16C-4M	16	23.5	4.0	5.0	5.90	M2	18.0
RCLA16C-5M	16	23.5	5.0	5.0	5.90	M2	18.0
RCLA16C-6M	16	23.5	5.0	6.0	5.90	M2	18.0
RCLA16C-7M	16	23.5	6.0	6.0	5.90	M2	18.0
RCLA16C-8M	16	23.5	6.0	8.0	5.90	M2	18.0
RCLA16C-9M	16	23.5	8.0	8.0	5.90	M2	18.0
RCLA20C-1M	20	26.0	4.0	4.0	6.60	M3	21.8
RCLA20C-2M	20	26.0	4.0	5.0	6.60	M3	21.8
RCLA20C-3M	20	26.0	5.0	5.0	6.60	M3	21.8
RCLA20C-4M	20	26.0	5.0	6.0	6.60	M3	21.8
RCLA20C-5M	20	26.0	6.0	6.0	6.60	M3	21.8
RCLA20C-6M	20	26.0	6.0	8.0	6.60	M3	21.8
RCLA20C-7M	20	26.0	8.0	8.0	6.60	M3	21.8
RCLA20C-8M	20	26.0	8.0	10.0	6.60	M3	21.8
RCLA20C-9M	20	26.0	10.0	10.0	6.60	M3	21.8
RCLA25C-1M	25	34.0	5.0	5.0	7.60	M3	26.9
RCLA25C-2M	25	34.0	5.0	6.0	7.60	M3	26.9
RCLA25C-3M	25	34.0	6.0	6.0	7.60	M3	26.9
RCLA25C-4M	25	34.0	6.0	8.0	7.60	M3	26.9
RCLA25C-5M	25	34.0	8.0	8.0	7.60	M3	26.9
RCLA25C-6M	25	34.0	8.0	10.0	7.60	M3	26.9
RCLA25C-7M	25	34.0	10.0	10.0	7.60	M3	26.9
RCLA25C-8M	25	34.0	10.0	12.0	7.60	M3	26.9
RCLA25C-9M	25	34.0	12.0	12.0	7.60	M3	26.9

## TECHNICAL FEATURES

- Zero backlash, reliable one-piece construction
- Unique design maximizes torsional stiffness without including high bearing loads
- Minimal velocity and positional fluctuations
- Over 50,000,000 test cycles at test load and 80% offset without failure
- Maintenance free
- Recommended temperature range -80°C to +80°C

## TECHNICAL SPECIFICATIONS

SIZE	TORSIONAL STIFFNESS mNm/arcmin	RADIAL COMPLIANCE microns/N	MISALIGNMENT			MAX. INERTIA g.cm <sup>2</sup>	MAX. MASS g	TYPICAL TORQUE CAPACITY			MAX. SPEED RPM
			PARALLEL MM	ANGULAR DEG.	AXIAL MM			REVERSING Nm	NONREV. Nm	PEAK Nm	
13C	15.56	64.3	0.15	2.5	±0.30	1.2	5.5	0.35	0.45	0.50	12000
16C	24.43	65.1	0.20	2.5	±0.40	3.3	10.6	0.55	0.85	1.25	10000
20C	40.43	62.0	0.25	3.0	±0.50	9.0	18.7	0.95	1.45	2.45	7500
25C	66.03	82.2	0.40	3.0	±0.70	31.0	3805	1.55	2.35	3.90	5000

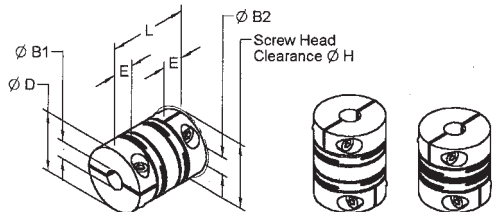

# RELI-A-FLEX COUPLINGS

BORES		STYLE		MATERIAL	
1.5MM TO 12MM		SET SCREW, SHORT		ALUMINUM 7075 ALOCROM FINISH	

STOCK NO.	L	ØD	ØB1 +.05 -.00	ØB2 +.05 -.00	E	SET SCREW SIZE
RCSA6-1M	6	9.35	1.5	1.5	2.80	M1.2 (SLOT SET SCREW)
RCSA6-2M	6	9.35	1.5	2.0	2.80	M1.2 (SLOT SET SCREW)
RCSA6-3M	6	9.35	2.0	2.0	2.80	M1.2 (SLOT SET SCREW)
RCSA6-4M	6	9.35	2.0	3.0	2.80	M1.2 (SLOT SET SCREW)
RCSA6-5M	6	9.35	3.0	3.0	2.80	M1.2 (SLOT SET SCREW)
RCSA8-1M	8	11.70	2.0	2.0	3.20	M1.6
RCSA8-2M	8	11.70	2.0	3.0	3.20	M1.6
RCSA8-3M	8	11.70	3.0	3.0	3.20	M1.6
RCSA8-4M	8	11.70	3.0	4.0	3.20	M1.6
RCSA8-5M	8	11.70	4.0	4.0	3.20	M1.6
RCSA10-1M	10	13.65	3.0	3.0	4.00	M2
RCSA10-2M	10	13.65	3.0	4.0	4.00	M2
RCSA10-3M	10	13.65	4.0	4.0	4.00	M2
RCSA10-4M	10	13.65	4.0	5.0	4.00	M2
RCSA10-5M	10	13.65	5.0	5.0	4.00	M2
RCSA13-1M	13	16.80	3.0	3.0	5.00	M2.5
RCSA13-2M	13	16.80	3.0	4.0	5.00	M2.5
RCSA13-3M	13	16.80	4.0	4.0	5.00	M2.5
RCSA13-4M	13	16.80	4.0	5.0	5.00	M2.5
RCSA13-5M	13	16.80	5.0	5.0	5.00	M2.5
RCSA13-6M	13	16.80	5.0	6.0	5.00	M2.5
RCSA13-7M	13	16.80	6.0	6.0	5.00	M2.5
RCSA16-1M	16	19.75	3.0	3.0	5.90	M3
RCSA16-2M	16	19.75	3.0	4.0	5.90	M3
RCSA16-3M	16	19.75	4.0	4.0	5.90	M3
RCSA16-4M	16	19.75	4.0	5.0	5.90	M3
RCSA16-5M	16	19.75	5.0	5.0	5.90	M3
RCSA16-6M	16	19.75	5.0	6.0	5.90	M3
RCSA16-7M	16	19.75	6.0	6.0	5.90	M3
RCSA16-8M	16	19.75	6.0	8.0	5.90	M3
RCSA16-9M	16	19.75	8.0	8.0	5.90	M3
RCSA20-1M	20	21.50	4.0	4.0	6.60	M4
RCSA20-2M	20	21.50	4.0	5.0	6.60	M4
RCSA20-3M	20	21.50	5.0	5.0	6.60	M4
RCSA20-4M	20	21.50	5.0	6.0	6.60	M4
RCSA20-5M	20	21.50	6.0	6.0	6.60	M4
RCSA20-6M	20	21.50	6.0	8.0	6.60	M4
RCSA20-7M	20	21.50	8.0	8.0	6.60	M4
RCSA20-8M	20	21.50	8.0	10.0	6.60	M4
RCSA20-9M	20	21.50	10.0	10.0	6.60	M4
RCSA25-1M	25	25.80	5.0	5.0	7.60	M5
RCSA25-2M	25	25.80	5.0	6.0	7.60	M5
RCSA25-3M	25	25.80	6.0	6.0	7.60	M5
RCSA25-4M	25	25.80	6.0	8.0	7.60	M5
RCSA25-5M	25	25.80	8.0	8.0	7.60	M5
RCSA25-6M	25	25.80	8.0	10.0	7.60	M5
RCSA25-7M	25	25.80	10.0	10.0	7.60	M5
RCSA25-8M	25	25.80	10.0	12.0	7.60	M5
RCSA25-9M	25	25.80	12.0	12.0	7.60	M5

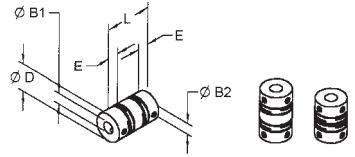

## TECHNICAL FEATURES

- Zero backlash, reliable one-piece construction
- Unique design maximizes torsional stiffness without including high bearing loads
- Minimal velocity and positional fluctuations
- Over 50,000,000 test cycles at test load and 80% offset without failure
- Maintenance free
- Recommended temperature range -80°C to +80°C

## TECHNICAL SPECIFICATIONS

SIZE	TORSIONAL STIFFNESS mNm/arcmin	RADIAL COMPLIANCE microns/N	MISALIGNMENT			MAX. INERTIA g.cm <sup>2</sup>	MAX. MASS g	TYPICAL TORQUE CAPACITY			MAX. SPEED RPM
			PARALLEL MM	ANGULAR DEG.	AXIAL MM			REVERSING Nm	NONREV. Nm	PEAK Nm	
6	1.22	21.0	0.020	1.7	±0.06	0.03	0.65	0.10	0.15	0.25	7000
8	2.53	35.0	0.050	2.0	±0.10	0.11	1.30	0.20	0.30	0.50	40000
10	4.89	28.0	0.060	2.0	±0.17	0.33	2.30	0.30	0.45	0.75	35000



# RELI-A-FLEX COUPLINGS

BORES		STYLE		MATERIAL	
1.5MM TO 12MM		SET SCREW, LONG		ALUMINUM 7075 ALOCROM FINISH	

STOCK NO.	L	ØD	ØB1 +.05 -.00	ØB2 +.05 -.00	E	SET SCREW SIZE
RCLA6-1M	6	12.5	1.5	1.5	2.80	M1.2 (SLOT SET SCREW)
RCLA6-2M	6	12.5	1.5	2.0	2.80	M1.2 (SLOT SET SCREW)
RCLA6-3M	6	12.5	2.0	2.0	2.80	M1.2 (SLOT SET SCREW)
RCLA6-4M	6	12.5	2.0	3.0	2.80	M1.2 (SLOT SET SCREW)
RCLA6-5M	6	12.5	3.0	3.0	2.80	M1.2 (SLOT SET SCREW)
RCLA8-1M	8	14.5	2.0	2.0	3.20	M1.6
RCLA8-2M	8	14.5	2.0	3.0	3.20	M1.6
RCLA8-3M	8	14.5	3.0	3.0	3.20	M1.6
RCLA8-4M	8	14.5	3.0	4.0	3.20	M1.6
RCLA8-5M	8	14.5	4.0	4.0	3.20	M1.6
RCLA10-1M	10	17.0	3.0	3.0	4.00	M2
RCLA10-2M	10	17.0	3.0	4.0	4.00	M2
RCLA10-3M	10	17.0	4.0	4.0	4.00	M2
RCLA10-4M	10	17.0	4.0	5.0	4.00	M2
RCLA10-5M	10	17.0	5.0	5.0	4.00	M2
RCLA13-1M	13	20.0	3.0	3.0	5.00	M2.5
RCLA13-2M	13	20.0	3.0	4.0	5.00	M2.5
RCLA13-3M	13	20.0	4.0	4.0	5.00	M2.5
RCLA13-4M	13	20.0	4.0	5.0	5.00	M2.5
RCLA13-5M	13	20.0	5.0	5.0	5.00	M2.5
RCLA13-6M	13	20.0	5.0	6.0	5.00	M2.5
RCLA13-7M	13	20.0	6.0	6.0	5.00	M2.5
RCLA16-1M	16	23.50	3.0	3.0	5.90	M3
RCLA16-2M	16	23.50	3.0	4.0	5.90	M3
RCLA16-3M	16	23.50	4.0	4.0	5.90	M3
RCLA16-4M	16	23.50	4.0	5.0	5.90	M3
RCLA16-5M	16	23.50	5.0	5.0	5.90	M3
RCLA16-6M	16	23.50	5.0	6.0	5.90	M3
RCLA16-7M	16	23.50	6.0	6.0	5.90	M3
RCLA16-8M	16	23.50	6.0	8.0	5.90	M3
RCLA16-9M	16	23.50	8.0	8.0	5.90	M3
RCLA20-1M	20	26.0	4.0	4.0	6.60	M4
RCLA20-2M	20	26.0	4.0	5.0	6.60	M4
RCLA20-3M	20	26.0	5.0	5.0	6.60	M4
RCLA20-4M	20	26.0	5.0	6.0	6.60	M4
RCLA20-5M	20	26.0	6.0	6.0	6.60	M4
RCLA20-6M	20	26.0	6.0	8.0	6.60	M4
RCLA20-7M	20	26.0	8.0	8.0	6.60	M4
RCLA20-8M	20	26.0	8.0	10.0	6.60	M4
RCLA20-9M	20	26.0	10.0	10.0	6.60	M4
RCLA25-1M	25	34.0	5.0	5.0	7.60	M5
RCLA25-2M	25	34.0	5.0	6.0	7.60	M5
RCLA25-3M	25	34.0	6.0	6.0	7.60	M5
RCLA25-4M	25	34.0	6.0	8.0	7.60	M5
RCLA25-5M	25	34.0	8.0	8.0	7.60	M5
RCLA25-6M	25	34.0	8.0	10.0	7.60	M5
RCLA25-7M	25	34.0	10.0	10.0	7.60	M5
RCLA25-8M	25	34.0	10.0	12.0	7.60	M5
RCLA25-9M	25	34.0	12.0	12.0	7.60	M5

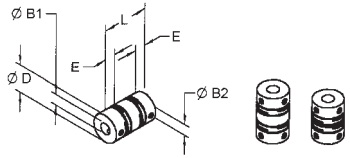

## TECHNICAL FEATURES

- Zero backlash, reliable one-piece construction
- Unique design maximizes torsional stiffness without including high bearing loads
- Minimal velocity and positional fluctuations
- Over 50,000,000 test cycles at test load and 80% offset without failure
- Maintenance free
- Recommended temperature range -80°C to +80°C

G

## TECHNICAL SPECIFICATIONS

SIZE	TORSIONAL STIFFNESS mNm/arcmin	RADIAL COMPLIANCE microns/N	MISALIGNMENT			MAX. INERTIA g.cm <sup>2</sup>	MAX. MASS g	TYPICAL TORQUE CAPACITY			MAX. SPEED RPM
			PARALLEL MM	ANGULAR DEG.	AXIAL MM			REVERSING Nm	NONREV. Nm	PEAK Nm	
6	1.25	79.0	0.040	1.7	±0.05	0.05	0.95	0.10	0.15	0.25	7000
8	2.53	102.0	0.100	2.0	±0.15	0.15	1.70	0.20	0.30	0.50	40000
10	4.89	83.0	0.120	2.0	±0.43	0.43	3.00	0.30	0.45	0.75	35000

# FLEX-THANE COUPLINGS

BORES	NO. OF PINS	MATERIAL
3MM TO 13MM	8 TO 11	POLYURETHANE PINS ALUMINUM DIN 3.1355 HUBS

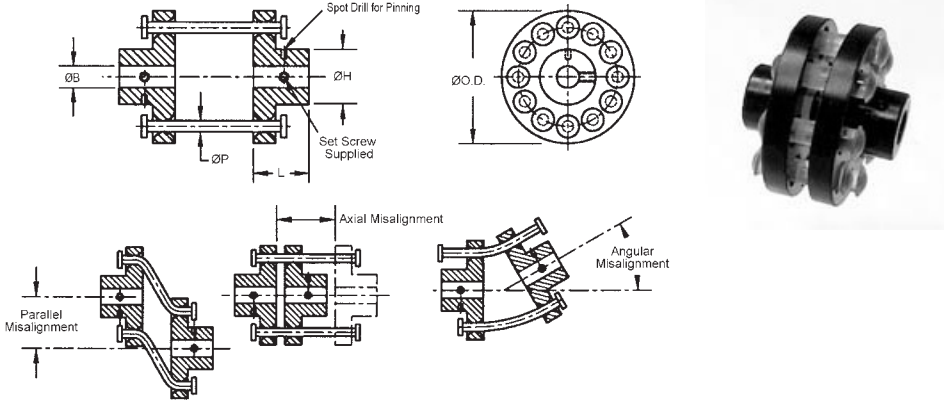

STOCK NO.	ØB +0.05	ØP	ØH	L	ØO.D.	NO. OF PINS	MAX WORKING TORQUE (N•CM)	MAX PARALLEL MISALIGN	MAX AXIAL MISALIGN	MAX ANGULAR MISALIGN
CC5M-10-L	3.00	1.6	8.0	8.0	17.5	8	280	1.6	3.6	10°
CC5M-19-L	5.00	3.2	9.5	8.7	25.5	8	390	3.2	4.8	
CC5M-28-L	7.00	3.2	12.7	11.0	32.0	10	560	6.4	6.4	
CC5M-32-L	8.00	4.8	12.7	11.0	38.0	10	680	5.6	7.9	
CC5M-35-L	10.00	6.4	19.0	19.0	50.0	11	1130	4.0	9.5	
CC5M-37-L	13.00	7.9	25.5	22.0	63.5	11	2260	3.2	12.7	
CC5M-10-A	3.00	1.6	8.0	8.0	17.5	8	280	12.7	11.0	30°
CC5M-19-A	5.00	3.2	9.5	8.7	25.5	8	390	16.0	16.0	
CC5M-28-A	7.00	3.2	12.7	11.0	32.0	10	560	19.0	22.0	
CC5M-32-A	8.00	4.8	12.7	11.0	38.0	10	680	22.0	28.5	
CC5M-35-A	10.00	6.4	19.0	19.0	51.0	11	1130	22.5	35.0	
CC5M-37-A	13.00	7.9	25.5	22.0	63.5	11	2260	32.0	51.0	

# ABSORBATHANE FLEXIBLE COUPLINGS

BORE	STYLE	MATERIAL
5.00 TO 10.00	EXTERNAL HUB	BLACK POLYURETHANE PLATED MILD STEEL HUBS

STOCK NO.	BORES $\varnothing B1$ and $\varnothing B2$ +0.05	$\varnothing A$	C	$\varnothing D$	MAX. WORKING TORQUE (N*cm)	MAX. PARALLEL MISALIGN	MAX. ANGULAR MISALIGN
CC3M-18 CC3M-19 CC3M-20 CC3M-21	5.00 6.00 8.00 10.00	28.5	28.5	17.5	30	2.4	10°

BORE	STYLE	MATERIAL
6.00 TO 13.00	INTERNAL HUB	BLACK POLYURETHANE PLATED MILD STEEL HUBS

STOCK NO.	BORES $\varnothing B1$ and $\varnothing B2$ +0.05	$\varnothing A$	C	$\varnothing D$	MAX. WORKING TORQUE (N*cm)	MAX. PARALLEL MISALIGN	MAX. ANGULAR MISALIGN
CC3M-22 CC3M-23 CC3M-24 CC3M-25 CC3M-26	6.00 8.00 10.00 11.00 13.00	47.5	44.5	25.5	135	3.2	15°

BORE	STYLE	MATERIAL
10.00 TO 16.00	INTERNAL HUB	BLACK POLYURETHANE PLATED MILD STEEL HUBS

STOCK NO.	BORES $\varnothing B1$ and $\varnothing B2$ +0.05	$\varnothing A$	C	$\varnothing D$	MAX. WORKING TORQUE (N*cm)	MAX. PARALLEL MISALIGN	MAX. ANGULAR MISALIGN
CC3M-27 CC3M-28 CC3M-29 CC3M-30 CC3M-31	10.00 11.00 13.00 14.00 16.00	54.0	54.0	32.0	315	4.7	15°

BORE	STYLE	MATERIAL
13.00 TO 16.00	INTERNAL HUB	BLACK POLYURETHANE PLATED MILD STEEL HUBS

STOCK NO.	BORES $\varnothing B1$ and $\varnothing B2$ +0.05	$\varnothing A$	C	$\varnothing D$	MAX. WORKING TORQUE (N*cm)	MAX. PARALLEL MISALIGN	MAX. ANGULAR MISALIGN
CC3M-32 CC3M-33 CC3M-34	13.00 14.00 16.00	54.0	60.5	32.0	450	3.2	15°

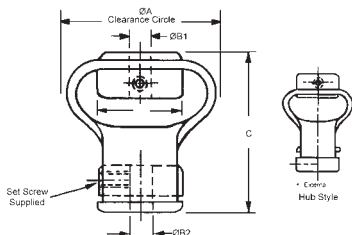

Available on request:  
Other bore sizes  
or bore combinations.

- Absorbs end play
- Quiet running
- Maintenance free (No moving parts)
- 3600 R.P.M. Maximum



# NEO-FLEX COUPLINGS

BORE	STYLE	MATERIAL
3MM TO 10MM	PIN HUB	STAINLESS STEEL DIN 1.4305 HUBS MOLDED NEOPRENE BODY

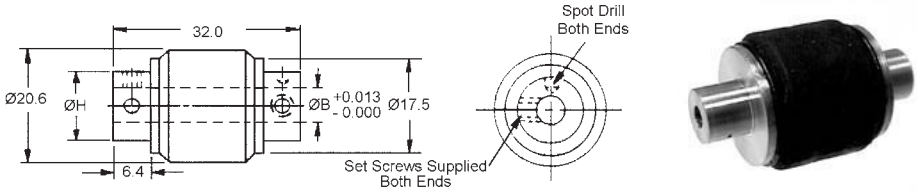

- Isolates torsional vibrations
- Insulates between shafts
- 1° angular misalignment (Max.)
- 0.13 Shaft misalignment (Max.)
- Maximum working torque of 105 N•cm

STOCK NO.	ØB	ØH	ØC
CO14M-1	2.995	7.9	4.6
CO14M-2	3.995	8.7	5.6
CO14M-3	4.995	9.7	6.6
CO14M-4	5.995	12.3	7.6
CO14M-5	7.995	12.8	9.6
CO14M-6	9.995	16.4	11.6

(Special bore sizes and mixed bore combinations available on request.)

BORE	STYLE	MATERIAL
5MM TO 13MM	PIN HUB	STAINLESS STEEL DIN 1.4305 HUBS POLYURETHANE CENTER

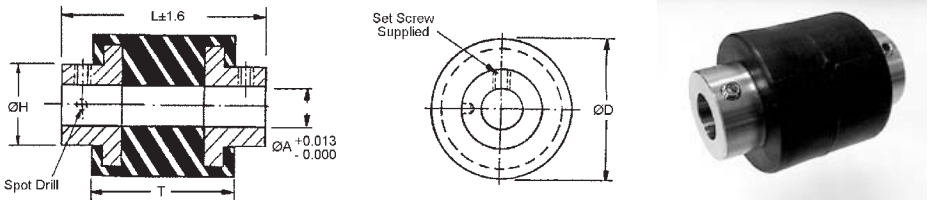

STOCK NO.	ØA	H	ØD	L	T
CC1-3M	4.995	9.5	23.8	31.8	19.1
CC1-14M	5.995	15.9	28.6	39.7	23.8
CC1-15M	7.995	15.9	28.6	39.7	23.8
CC1-16M	9.995	15.9	28.6	39.7	23.8
CC1-8M	12.995	25.4	41.3	57.2	35.0

Combination bores are available on request.

# NEO-FLEX COUPLINGS

BORE	STYLE	MATERIAL
3MM TO 10MM	CLAMP HUB	STAINLESS STEEL DIN 1.4305 HUBS MOLDED NEOPRENE BODY

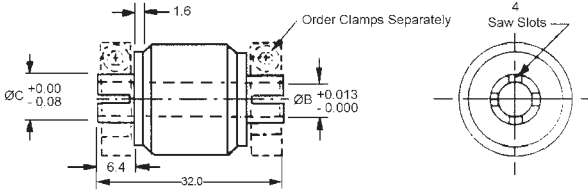

- Isolates torsional vibrations
- Insulates between shafts
- 1° angular misalignment (Max.)
- 0.13 Shaft misalignment (Max.)
- Maximum working torque of 105 N\*cm

STOCK NO.	$\varnothing B$	$\varnothing H$	$\varnothing C$	CLAMP STOCK NO.
CO15M-1	2.995	7.9	4.6	CG1M-4
CO15M-2	3.995	8.7	5.6	CG1M-5
CO15M-3	4.995	9.7	6.6	CG1M-8
CO15M-4	5.995	12.3	7.6	CG1M-11
CO15M-5	7.995	12.8	9.6	CG1M-14
CO15M-6	9.995	16.4	11.6	CG1M-16

(Special bore sizes and mixed bore combinations available on request.)

BORE	STYLE	MATERIAL
5MM TO 13MM	CLAMP HUB	STAINLESS STEEL DIN 1.4305 HUBS POLYURETHANE CENTER

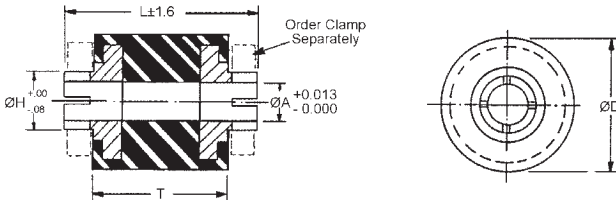

STOCK NO.	$\varnothing A$	H	$\varnothing D$	L	T
CC1-3M	4.995	6.6	23.8	31.8	19.1
CC1-14M	5.995	7.6	28.6	39.7	23.8
CC1-15M	7.995	9.6	28.6	39.7	23.8
CC1-16M	9.995	11.6	28.6	39.7	23.8
CC1-8M	12.995	14.6	41.3	57.2	35.0

Combination bores are available on request.

# SLEEVE COUPLINGS

BORE	STYLE	MATERIAL
3MM TO 25MM	SET SCREW	STAINLESS STEEL DIN 1.4305

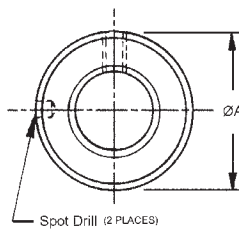
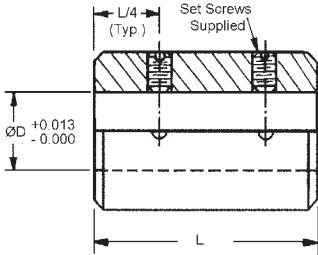

STOCK NO.	SHAFT SIZE	$\varnothing D$	L	$\varnothing A$
CTM-1	3	2.995	11	9
CTM-2	4	3.995	13	9
CTM-3	6	5.995	15	13
CTM-4	8	7.995	15	13
CTM-5	9	8.995	19	19
CTM-6	9	8.995	25	19
CTM-7	12	11.995	25	25
CTM-8	12	11.995	38	25
CTM-9	16	15.995	50	32
CTM-10	19	18.995	50	38
CTM-11	25	24.995	76	50
CTM-12	3-4	2.995 3.995	11	9
CTM-13	3-5	2.995 4.995	13	9
CTM-14	3-6	2.995 5.995	14	13
CTM-15	4-6	3.995 5.995	14	13
CTM-16	5-6	4.995 5.995	14	13
CTM-17	6-8	5.995 7.995	14	14
CTM-18	6-9	5.995 8.995	19	19
CTM-19	8-9	7.995 8.995	19	19
CTM-20	9-12	8.995 11.995	25	25

Modified or specials are available on request.

# SPIDER COUPLINGS

BORES	DESCRIPTION	MATERIAL
3MM TO 12MM	SOFT 80 DURO SPIDER	ALUMINUM HUBS POLYURETHANE SPIDER

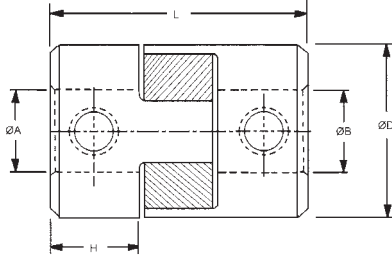

SOFT 80 DURO SPIDER STOCK NO.	ØA H10	ØB H10	ØD	H	L	MAX. WORKING TORQUE (N•cm) 80 DURO	MAX. PARALLEL MISALIGN.	MAX. ANGULAR MISALIGN.
CO46M-1A CO46M-2A	3.00 5.00	3.00 5.00	10.0	5.0	15.0	30	0.8	1°
CO47M-1A CO47M-2A CO47M-3A	3.00 5.00 7.00	3.00 5.00 7.00	14.0	7.0	22.0	140	1.2	
CO48M-1A CO48M-2A CO48M-3A	7.00 8.00 10.00	7.00 8.00 10.00	20.0	10.0	30.0	360	1.6	
CO49M-1A CO49M-2A CO49M-3A	8.00 10.00 12.00	8.00 10.00 12.00	30.0	11.0	35.0	800	2.0	

- Backlash free coupling for feedback devices, stepper motors and positioning devices.
- Torsional rigidity
- Contoured and machined components for quick assembly and minimum wear over extended use. Components assembled with pre-load.
- Bearing protection from parallel and angular misalignment
- Allowance for axial shaft float
- Small size, low  $WR^2$ , electrical isolation and light weight aluminum hubs.

Other bore sizes and combinations are available on request.  
Clamp style couplings are available on request.

# SPIDER COUPLINGS

BORE	DESCRIPTION	MATERIAL
3MM TO 12MM	RIGID 98 DURO SPIDER	ALUMINUM HUBS POLYURETHANE SPIDER

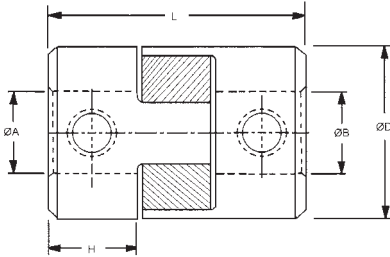

SOFT 98 DURO SPIDER STOCK NO.	ØA H10	ØB H10	ØD	H	L	MAX. WORKING TORQUE (N•cm) 98 DURO	MAX. PARALLEL MISALIGN.	MAX. ANGULAR MISALIGN.
CO46M-1B CO46M-2B	3.00 5.00	3.00 5.00	10.0	5.0	15.0	100	0.8	1°
CO47M-1B CO47M-2B CO47M-3B	3.00 5.00 7.00	3.00 5.00 7.00	14.0	7.0	22.0	400	1.2	
CO48M-1B CO48M-2B CO48M-3B	7.00 8.00 10.00	7.00 8.00 10.00	20.0	10.0	30.0	1000	1.6	
CO49M-1B CO49M-2B CO49M-3B	8.00 10.00 12.00	8.00 10.00 12.00	30.0	11.0	35.0	2500	2.0	

- Backlash free coupling for feedback devices, stepper motors and positioning devices.
- Torsional rigidity
- Contoured and machined components for quick assembly and minimum wear over extended use. Components assembled with pre-load.
- Bearing protection from parallel and angular misalignment
- Allowance for axial shaft float
- Small size, low WR<sup>2</sup>, electrical isolation and light weight aluminum hubs.

Other bore sizes and combinations are available on request.  
 Clamp style couplings are available on request.



# MULTI-JAW COUPLINGS

BORE	MATERIAL
3MM TO 13MM	STAINLESS STEEL DIN 1.4305

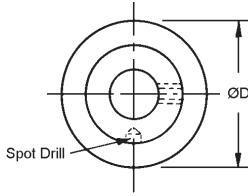
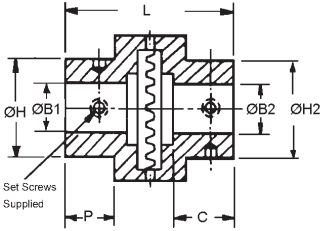

STOCK NO.	ØB1 +.013 -.000	ØB2 +.013 -.000	H1	H2	L	C	P	ØD	NO. OF TEETH	MAX. TORQUE (N•cm)
CM3M-1	2.995	2.995	8.0	8.0						
CM3M-2	2.995	3.995	8.0	9.0						
CM3M-3	3.995	3.995	9.0	9.0						
CM3M-4	3.995	4.995	9.0	10.0						
CM3M-5	3.995	5.995	9.0	13.0	20.0	6.0	6.0	14	32	200
CM3M-6	4.995	4.995	10.0	10.0						
CM3M-7	4.995	5.995	10.0	13.0						
CM3M-8	5.995	5.995	13.0	13.0						
CM1M-1	2.995	3.995	8.0	9.0						
CM1M-2	3.995	3.995	9.0	9.0						
CM1M-3	3.995	4.995	9.0	10.0						
CM1M-4	3.995	5.995	9.0	13.0	22.0	6.0	7.0	19	48	350
CM1M-5	4.995	4.995	10.0	10.0						
CM1M-6	4.995	5.995	10.0	13.0						
CM1M-7	5.995	5.995	13.0	13.0						
CM1M-8	7.995	7.995	13.0	13.0						
CM1M-9	9.995	9.995	18.0	18.0	32.0	11.0	8.0	25	64	640
CM1M-10	12.995	12.995	24.0	24.0	38.0	14.0	11.0			

1.3 Disengagement and assembly clearance.

Other bore to bore combinations can be assembled to order from stock.

G

BORE	MATERIAL
5MM TO 13MM	STEEL DIN 1.0718 HEAVY DUTY

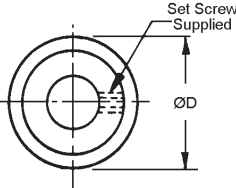
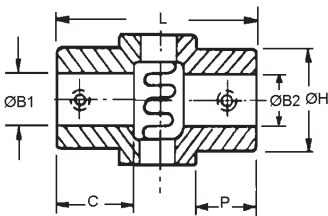

STOCK NO.	ØB1 +.05 -.00	ØB2 +.05 -.00	ØD	L	C	ØH	P	NO. OF TEETH	MAX. TORQUE (N•cm)
CM2M-1	5.00	5.00	13	28	13	11.0	11	10	280
CM2M-2	6.00	6.00	13	28	13	11.0	11	10	280
CM2M-3	8.00	8.00	19	38	16	17.0	13	10	460
CM2M-4	10.00	10.00	19	38	16	17.0	13	10	460
CM2M-5	13.00	13.00	25	51	22	23.0	19	12	780

7.1 Disengagement & Assembly Clearance

# BELLOWS COUPLINGS

BORE	STYLE	MATERIAL
3MM TO 10MM	PIN HUB	STAINLESS STEEL DIN 1.4305

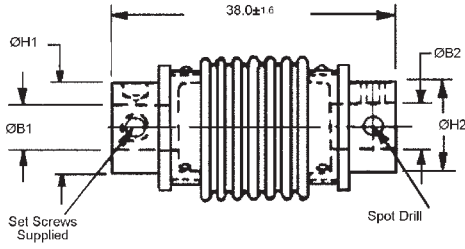

STOCK NO.	ØB1 H6	ØB2 H6	ØH1	ØH2
CO5M-1	2.995	2.995	8	8
CO5M-2	2.995	3.995	8	9
CO5M-3	2.995	4.995	8	10
CO5M-4	2.995	5.995	8	13
CO5M-5	3.995	3.995	9	9
CO5M-6	3.995	4.995	8	10
CO5M-7	3.995	5.995	8	13
CO5M-8	4.995	4.995	10	10
CO5M-9	4.995	5.995	10	11
CO5M-10	5.995	6.995	11	13
CO5M-11	5.995	5.995	11	11
CO5M-12	7.995	7.995	13	13
CO5M-13	9.995	9.995	15	15

- Eliminates end play
- Zero backlash
- Provides uniform angular velocity
- Absorbs vibration, noise and shock

Other bore sizes available.

BORE	STYLE	MATERIAL
3MM TO 10MM	CLAMP HUB	STAINLESS STEEL DIN 1.4305

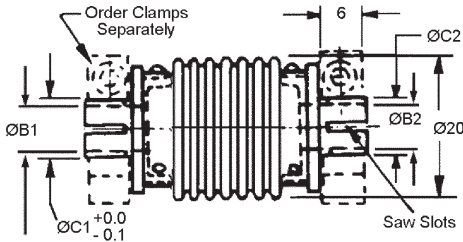

STOCK NO.	ØB1 H6	ØB2 H6	ØH1	ØH2
CO5M-1C	2.995	2.995	4.6	4.6
CO5M-2C	2.995	3.995	4.6	5.6
CO5M-3C	2.995	4.995	4.6	6.6
CO5M-4C	2.995	5.995	4.6	7.6
CO5M-5C	3.995	3.995	5.6	5.6
CO5M-6C	3.995	4.995	5.6	6.6
CO5M-7C	3.995	5.995	5.6	7.6
CO5M-8C	4.995	4.995	6.6	6.6
CO5M-9C	4.995	5.995	6.6	7.6
CO5M-10C	5.995	6.995	7.6	8.6
CO5M-11C	5.995	5.995	7.6	7.6
CO5M-12C	7.995	7.995	9.6	9.6
CO5M-13C	9.995	9.995	11.6	11.6

- Eliminates end play
- Zero backlash
- Provides uniform angular velocity
- Absorbs vibration, noise and shock

Other bore sizes available.

# OLDHAM COUPLINGS

BORE	STYLE	MATERIAL
4MM TO 13MM	PIN HUB	STAINLESS STEEL DIN 1.4305 HUBS CENTER BLOCK: U = POLYURETHANE B = BRONZE OR N = NYLON

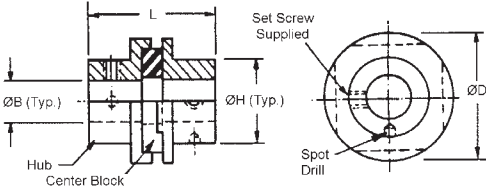

- Shaft to shaft misalignment 0.3 maximum
- Angular misalignment 1° maximum
- Maximum backlash 10 minutes

STOCK NO.	ØB +0.013 -0.000	ØD	ØH	L	MAX. TORQUE N*cm.	
CO3-4M-U CO3-4M-B CO3-4M-N	3.995	15.9	7.9	16.7	U = 50 B = 250 N = 75	
CO3-5M-U CO3-5M-B CO3-5M-N	4.995	15.9	9.5	18.3		
CO3-6M-U CO3-6M-B CO3-6M-N	5.995	15.9	12.7	19.8		
CO3-8M-U CO3-8M-B CO3-8M-N	7.995	15.9	12.7	19.8		
CO3-10M-U CO3-10M-N	9.995	34.9	19.1	39.7		U = 250 N = 360
CO3-13M-U CO3-13M-B CO3-13M-N	12.995	38.1	25.4	46.0		U = 300 B = 1225 N = 430

BORES	STYLE	MATERIAL
2MM TO 16MM	PIN HUB	ALUMINUM HUBS DELRIN INSERTS

STOCK NO.	ØA +0.03	ØB +0.03	E	ØO.D.	L	MAX. WORKING TORQUE (N*cm)	MAX. PARALLEL MISALIGNMENT	MAX. ANGULAR MISALIGNMENT
CO30-B	SOLID	SOLID	-	6.3	12.7	10	.7	1/2°
CO30M-1*	2.00	2.00	3.8					
CO30M-2*	3.00	3.00	3.8					
CO31-B	SOLID	SOLID	-	9.5	12.7	20	.9	
CO31M-1*	3.00	3.00	3.8					
CO31M-2*	4.00	4.00	3.8					
CO32-B	SOLID	SOLID	-	12.7	15.9	49	1.2	
CO32M-1	3.00	3.00	4.3					
CO32M-2	4.00	4.00						
CO32M-3	6.00	6.00						
CO33-B	SOLID	SOLID	-	19.1	22.0	169	2.0	
CO33M-1	4.00	4.00	6.3					
CO33M-2	5.00	5.00						
CO33M-3	6.00	6.00						
CO33M-4	8.00	8.00						
CO34-B	SOLID	SOLID	-	25.4	28.4	395	2.5	
CO34M-1	6.00	6.00	8.6					
CO34M-2	8.00	8.00						
CO34M-3	10.00	10.00						
CO60-B	SOLID	SOLID	-	33.3	48.0	904	3.3	
CO60M-1	8.00	8.00	13.0					
CO60M-2	10.00	10.00						
CO60M-3	12.00	12.00						
CO35-B	SOLID	SOLID	-	41.3	50.8	2250	4.0	
CO35M-1	10.00	10.00	16.7					
CO35M-2	12.00	12.00						
CO35M-3	14.00	14.00						
CO35M-4	16.00	16.00						

NOTE: Hubs are interchangeable within the same series. Special combinations will be assembled to order. Set screws are omitted from blanks. One (1) set screw supplied to bores marked (\*), two (2) set screws supplied otherwise.

- Simple construction
- No backlash
- Corrosion resistant
- Reduces vibration
- Electrical Isolation
- No lubrication required

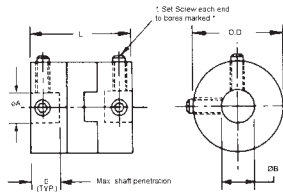

# OLDHAM COUPLINGS

BORE	STYLE	MATERIAL
4MM TO 6MM	CLAMP HUB	STAINLESS STEEL DIN 1.4305 HUBS CENTER BLOCK: U = POLYURETHANE B = BRONZE OR N = NYLON

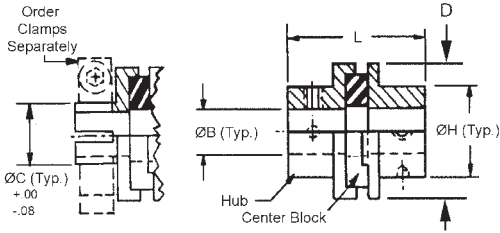

STOCK NO.	ØB +0.013 -0.000	ØD	ØH	L	MAX. TORQUE N•cm.
CO6-4M-U CO6-4M-B CO6-4M-N	3.995	15.9	5.6	21.4	U = 50 B = 250 N = 75
CO6-5M-U CO6-5M-B CO6-5M-N	4.995	15.9	6.6		
CO6-6M-U CO6-6M-B CO6-6M-N	5.995	15.9	7.6		

- Shaft to shaft misalignment 0.3 maximum
- Angular misalignment 1° maximum
- Maximum backlash 10 minutes

BORE	STYLE	MATERIAL
4MM TO 16MM	CLAMP HUB	ALUMINUM HUBS DELRIN CENTER BLOCK

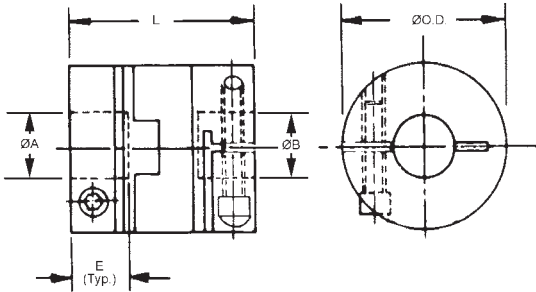

STOCK NO.	ØA +0.03	ØB +0.03	E	ØO.D.	L	MAX. WORKING TORQUE (N•cm)	MAX. PARALLEL MISALIGNMENT	MAX. ANGULAR MISALIGNMENT
CO33M-1C CO33M-4C	4.00 8.00	4.00 8.00	6.3	19.1	22.0	169	2.0	1/2°
CO34M-1C CO34M-2C CO34M-3C	6.00 8.00 10.00	6.00 8.00 10.00	8.6	25.4	28.4	395	2.5	
CO60M-1C CO60M-2C CO60M-3C	8.00 10.00 12.00	8.00 10.00 12.00	13.0	33.3	48.0	904	3.3	
CO35M-1C CO35M-2C CO35M-3C CO35M-4C	10.00 12.00 14.00 16.00	10.00 12.00 14.00 16.00	16.7	41.3	50.8	2250	4.0	

- Simple construction
- Reduces vibration
- No backlash
- Electrical Isolation
- Corrosion resistant
- No lubrication required

# UNIVERSAL LATERAL COUPLINGS

BORE	STYLE	MATERIAL
3MM TO 16MM	PIN HUB	DELRIN OUTER RING BRASS OR ALUMINUM HUBS

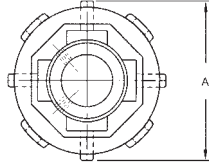
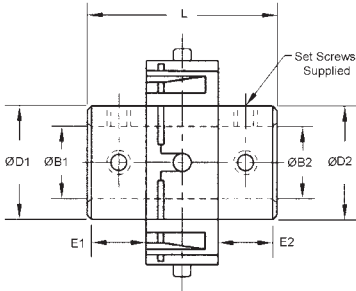

STOCK NO.	ØB1 +0.03	ØB2 +0.03	ØD1	ØD2	E1	E2	L	A	MAX WORKING TORQUE (N•cm)	MAX PARALLEL MISALIGN.	MAX - ANGULAR MISALIGN.	HUB MATERIAL
CO26M-1	3.00	3.00	8.9	8.9	4.0	4.0	14.2	18	27	1.3	10°	BRASS
CO26M-2	4.00	4.00										
CO26M-3	5.00	5.00										
CO26M-4	4.00	6.00	8.9	11.1	4.0	6.5	16.7					
CO26M-5	6.00	6.00	11.1	11.1	6.5	6.5	19.1					
CO23M-1	3.00	6.00	12.7	12.7	4.8	4.8	19.1	27.2	169			
CO23M-2	4.00	4.00										
CO23M-3	4.00	6.00										
CO23M-4	6.00	6.00										
CO23M-5	8.00	8.00										
CO23M-6	6.00	10.00	12.7	15.1	4.8	7.9	22.3					
CO23M-7	8.00	8.00										
CO23M-8	10.00	10.00	15.1	15.1	7.9	7.9	25.4					
CO25XM-1	6.00	6.00	17.6	17.6	7.6	7.6	25.2	33.7	248			
CO25XM-2	6.00	10.00										
CO25XM-3	8.00	8.00										
CO25XM-4	10.00	12.00	17.6	20.1	7.6	10.2	28.0					
CO25XM-5	12.00	12.00	20.1	20.1	10.2	10.2	30.7					
CO25M-1	6.00	6.00	22.1	22.1	7.6	7.6	28.4	41.4	429			
CO25M-2	7.00	7.00										
CO25M-3	8.00	8.00										
CO25M-4	10.00	10.00										
CO25M-5	16.00	16.00	24.2	24.2	12.5	12.5	38.1					

- Zero backlash
- Offers simultaneous lateral & angular misalignment
- Corrosion resistant
- No lubrication required
- Resonance damping
- Low inertia
- Shafts can pass through for easy installation
- Maximum operating temperature 60°C
- Misalignment
  - Angular 10° maximum
  - Lateral .050 maximum

G

# UNIVERSAL LATERAL COUPLINGS

BORE	STYLE	MATERIAL
3.18MM TO 12MM	CLAMP	DELRIN OUTER RING BRASS OR ALUMINUM HUBS

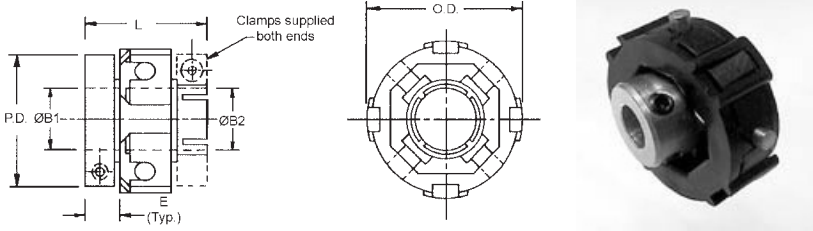

STOCK NO.	ØB1 +0.03 -0.00	ØB2 +0.03 -0.00	ØD	E	L	MAXIMUM WORKING TORQUE (N•cm)	O.D.	HUB MATERIAL
CO27-3 CO27M-1 CO27-6	3.18 6.00 6.35	6.35 6.00 6.35	19.1	6.5	19.1	27	19.1	TARNISH RESISTANT BRASS
CO28M-1 CO28M-2 CO28M-3 CO28M-4	5.00 6.00 6.00 7.00	5.00 6.00 8.00 7.00	27.2	7.9	25.4	169	27.9	
CO29XM-1 CO29XM-2 CO29XM-3 CO29XM-4	6.00 6.00 8.00 10.00	6.00 8.00 10.00 10.00	20.1	10.2	30.7	248	33.7	
CO29M-1 CO29M-2 CO29M-3 CO29M-4 CO29M-5 CO29M-6	6.00 6.00 8.00 10.00 11.00 12.00	6.00 12.00 8.00 12.00 11.00 12.00	24.2	12.5	38.1	429	41.4	

- Low inertia
- Resonance damping
- Electrically insulated
- Zero backlash
- Offers simultaneous lateral & angular misalignment
- Corrosion resistant
- No lubrication required
- Shafts can pass through for easy installation
- Maximum operating temperature 60°C
- Misalignment
  - Angular 10° maximum
  - Lateral .050 maximum

\*Clamp hub is integral to hub on CO29 series.  
Compatible with 2mm or 5/64" key.  
Additional sizes and bore combinations available on request.

# WAFER SPRING COUPLINGS

BORE	STYLE	MATERIAL
3MM TO 12MM	PIN HUB	HUBS AND CENTER BLOCK: ALUMINUM LEAVES: BERYLLIUM COPPER or STAINLESS STEEL

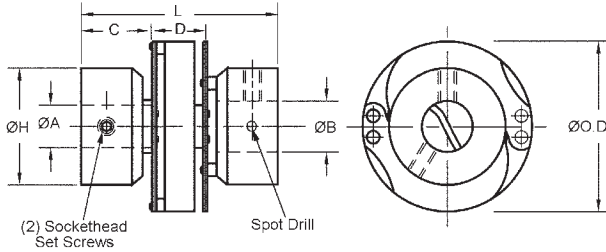

STOCK NO.	ØA +0.03	ØB +0.03	L	ØH	C	ØO.D.	MAX. WORKING OUTSIDE DIA.	MAX. TORQUE (N*cm)	MAX. PARALLEL MISALIGNMENT	MAX. ANGULAR MISAIGNMENT	MOMENT OF INERTIA (Kgm <sup>2</sup> )
CO20M-1P	3.00	3.00									
CO20M-2P	3.00	4.00									
CO20M-3P	3.00	5.00									
CO20M-4P	3.00	6.00									
CO20M-5P	4.00	4.00	22.3	14.2	7.5	7.1	19.1	115	0.4	8°	.365
CO20M-6P	4.00	5.00									
CO20M-7P	4.00	6.00									
CO20M-8P	5.00	5.00									
CO20M-9P	5.00	6.00									
CO20M-10P	6.00	6.00									
CO20M-11P	6.00	7.00	30.7	19.1	11.1	8.4	25.4	160	0.5		
CO20M-12P	6.00	8.00									
CO20M-13P	7.00	7.00									
CO20M-14P	7.00	8.00									
CO20M-15P	8.00	8.00									
CO20M-16P	6.00	10.00	46.2	25.4	16.7	12.7	38.1	310	0.7	11.523	
CO20M-17P	6.00	12.00									
CO20M-18P	8.00	10.00									
CO20M-19P	8.00	12.00									
CO20M-20P	10.00	10.00									
CO20M-21P	10.00	12.00									
CO20M-22P	12.00	10.00									

G

# WAFER SPRING COUPLINGS

BORE	STYLE	MATERIAL
3MM TO 12MM	CLAMP HUB	HUBS AND CENTER BLOCK: ALUMINUM LEAVES: BERYLLIUM COPPER or STAINLESS STEEL

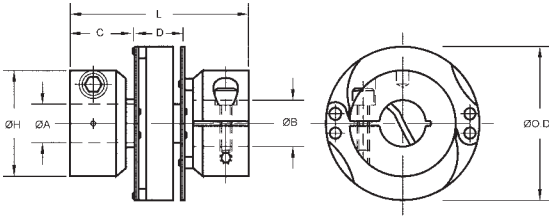

STOCK NO.	ØA +0.03	ØB +0.03	L	ØH	C	ØO.D.	MAX. WORKING OUTSIDE DIA.	MAX. TORQUE (N*cm)	MAX. PARALLEL MISALIGNMENT	MAX. ANGULAR MISAIGNMENT	MOMENT OF INERTIA (Kg <sup>m2</sup> )
CO20M-1	3.00	3.00	23.9	14.3	7.5	7.1	19.1	115	0.4	8°	.365
CO20M-2	3.00	4.00									
CO20M-3	3.00	5.00									
CO20M-4	3.00	6.00									
CO20M-5	4.00	4.00									
CO20M-6	4.00	5.00									
CO20M-7	4.00	6.00									
CO20M-8	5.00	5.00									
CO20M-9	5.00	6.00									
CO20M-10	6.00	6.00									
CO20M-11	6.00	7.00	30.7	19.1	11.1	8.4	25.4	160	0.5	8°	1.223
CO20M-12	6.00	8.00									
CO20M-13	7.00	7.00									
CO20M-14	7.00	8.00									
CO20M-15	8.00	8.00									
CO20M-16	6.00	10.00	46.2	25.4	16.7	12.7	38.1	310	0.7	8°	11.523
CO20M-17	6.00	12.00									
CO20M-18	8.00	10.00									
CO20M-19	8.00	12.00									
CO20M-20	10.00	10.00									
CO20M-21	10.00	12.00									
CO20M-22	12.00	10.00									



# UNIVERSAL JOINTS

BORE	STYLE	MATERIAL
3MM TO 13MM	PIN	STAINLESS STEEL DIN 1.4305

STOCK NO.	$\varnothing B$ +0.013	$\varnothing H$	L	A BORE LENGTH	MAX. WORKING TORQUE	MAX. ANGULAR MISALIGNMENT (N°cm)	FIG.
UJM-1	2.995	8.0	38.0	11.0	339	30°@ 500 RPM 10°@ 1000 RPM	2
UJM-2	4.995	9.5	38.0	11.0	339		2
UJM-3	5.995	12.5	38.0	11.0	339		1
UJM-4	7.995	12.5	38.0	11.0	339		1
UJM-5	9.995	19.0	66.5	23.5	904		1
UJM-6	12.995	25.5	85.5	29.5	2994		1

- Maximum parallel misalignment 0:0
- Ideal operating angle 10° at 1000 RPM
- Lubrication required at all times

Special bore and bore-to-bore connections available on request.

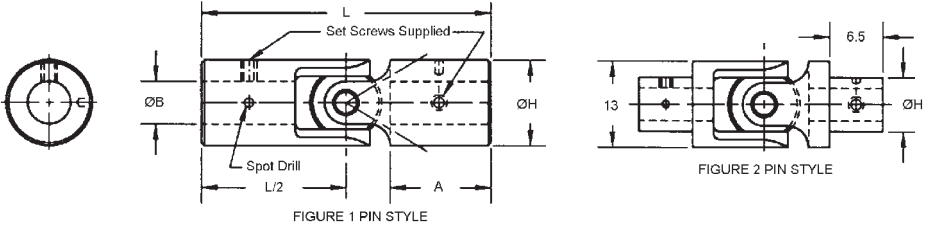

BORE	STYLE	MATERIAL
3MM TO 6MM	CLAMP	STAINLESS STEEL DIN 1.4305

STOCK NO.	$\varnothing B$ +0.013	$\varnothing H$	L	CLAMP BORE LENGTH	CLAMP STOCK NO.	MAX. TORQUE (N°cm)	MAX. ANGULAR MISALIGNMENT
UJM-10	2.995	4.6	35.0	10.0	CG1M-4	339	30°@ 500 RPM 10°@ 1000 RPM
UJM-11	4.995	6.6			CG1M-10		
UJM-12	5.995	7.6			CG1M-11		

- Maximum parallel misalignment 0:0
- Ideal operating angle 10° at 1000 RPM
- Lubrication required at all times

Special bore and bore-to-bore connections available on request.

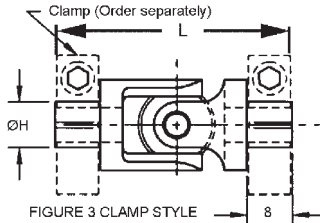

# UNIVERSAL JOINTS

BORES	STYLE	MATERIAL
3MM TO 10MM	SINGLE AND DOUBLE JOINT	DELRIN BODY BRASS HUB ENDS AND SPIDER

SINGLE JOINT	DOUBLE JOINT	ØB1 +0.03	ØB2 +0.03	L	ØA	C	D	M
STOCK NUMBER	STOCK NUMBER							
UJS-1M	UJD-1M	* 3.00	* 3.00	27.2	6.3	7.11	8.1	35.3
UJS-2M	UJD-2M	* 3.00	* 3.00	37.6	9.5	11.1	13.2	50.8
UJS-3M	UJD-3M	4.00	4.00					
UJS-4M	UJD-4M	5.00	5.00					
UJS-5M	UJD-5M	6.00	6.00	46.2	12.7	14.3	15.9	62.1
UJS-6M	UJD-6M	6.00	6.00	67.6	15.9	17.5	22.2	89.8
UJS-7M	UJD-7M	8.00	8.00					
UJS-8M	UJD-8M	10.00	10.00					

## Reference Data:

STOCK NUMBER	STOCK NUMBER	MAX. WORKING TORQUE (N-cm)		MAX. PARALLEL MISALIGNMENT		MAX. ANGULAR MISALIGNMENT	
		SINGLE JOINT	DOUBLE JOINT	SINGLE JOINT	DOUBLE JOINT	SINGLE JOINT	DOUBLE JOINT
UJS-1M	UJD-1M	11	8	0	5.6	45°	90°
UJS-2M	UJD-2M	39	16		9.1		
UJS-3M	UJD-3M		59		10.9		
UJS-4M	UJD-4M						
UJS-5M	UJD-5M	107	129		15.5		
UJS-6M	UJD-6M	169	129	15.5			
UJS-7M	UJD-7M						
UJS-8M	UJD-8M						

\* 3.00mm bore couplings are supplied with one set screw each end.

- Needs no lubrication
- Can be submersed in water
- Resists corrosion and chemical attack
- Electrically isolates input from output
- Zero backlash
- Lightweight
- Shock absorbent
- Non contaminant
- Temperature Range -40° F to +185° F

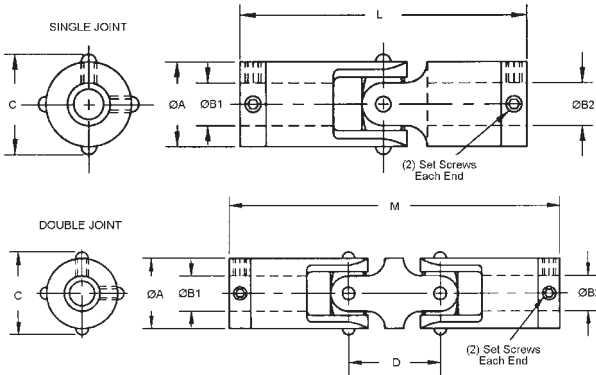

# TELESCOPIC UNIVERSAL JOINTS

BORE	MATERIAL
3MM TO 10MM	DELRIN BODY BRASS ENDS, SPIDER AND TELESCOPIC SECTIONS

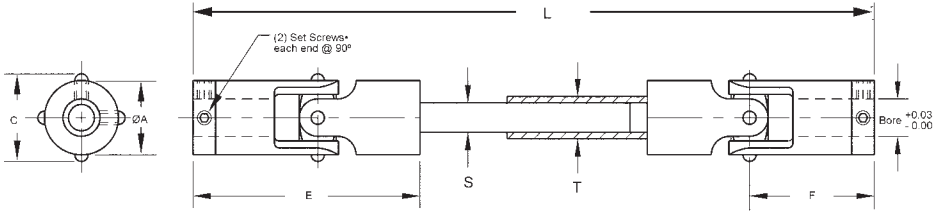

STOCK NUMBER	BORES	ØA	C	L		E	F	MAXIMUM TORQUE N*cm		SQ.	SQ.
				MAX	MIN			BREAK	WORKING		
				UJT-1M	3.00						
UJT-2M	4.00	9.5	10.2	134	104	32.9	18.8	191	39	3.2	4.8
UJT-3M	5.00										
UJT-4M	6.00	12.7	13.8	186	139	40.9	23.1	451	107	4.8	6.4
UJT-5M	10.00	15.9	17.2	260	198	60.3	33.8	677	169	6.4	8.0

Minimum length can be reduced by cutting equal lengths off both telescope halves.

- Temperature Range -40° C to +85° C
- Needs no lubrication
- Can be submersed in water
- Resists corrosion
- Electrically isolates input from output
- Minimum Backlash
- Lightweight
- Non contaminant (e.g. food, textiles and paper handling)
- Non-magnetic
- Resists chemical attack
- Shock absorbent



# SHAFT ADAPTERS

BORE	STYLE	MATERIAL
3MM TO 10MM	CLAMP	STAINLESS STEEL DIN 1.4305

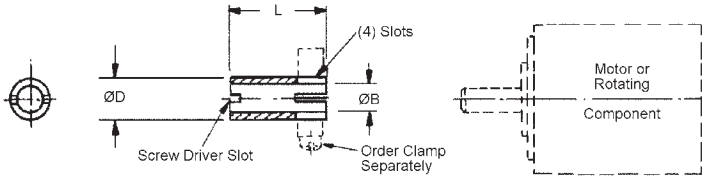

STOCK NUMBER	$\varnothing B$ +0.03	$\varnothing D$ -0.03	L
SAM-10	3.00	4.00	11
SAM-11	3.00	5.00	10
SAM-12	3.00	6.00	11
SAM-13	4.00		
SAM-14	5.00		
SAM-15	5.00	8.00	11
SAM-16	6.00		
SAM-18	6.00	10.00	13
SAM-19	8.00		
SAM-20	6.00	12.00	13
SAM-21	8.00		
SAM-22	10.00		

**Modifications and specials are available upon request.**

# SLIP COUPLINGS

BORE	TORQUE	MATERIAL
6MM AND 8MM	ADJUSTABLE 2.4 N.cm TO 132.4 N.cm	HOUSING, ADJUSTER RING AND ADAPTERS - ALUMINUM WITH ALOCROM FINISH, HUBS AND PLATES - HEAT TREATED STEEL, BEARING - SINTERED BRONZE

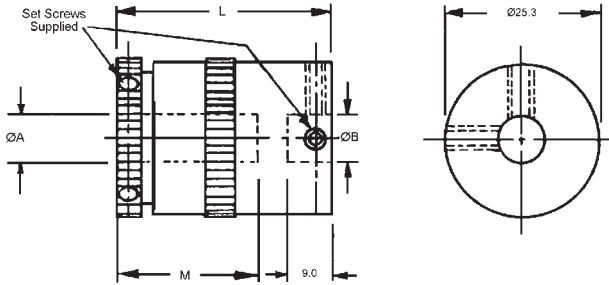

STOCK NO.	ØA BORE +0.03	ØB BORE +0.03	L	M	ADJUSTABLE TORQUE RANGE N*cm		WEIGHT
					MIN.	MAX.	
JJ-25M JJ-26M	6.00 8.00	6.00 8.00	36.0	25.0	2.4	53.0	50g
JJ-27M JJ-28M	6.00 8.00	6.00 8.00	42.5	31.0	7.8	132.4	61g

- Bi-directional
- Maximum operating Temperature 80°C
- Maximum backlash 2°

# OLDHAM SLIP COUPLINGS

BORE	TORQUE	MATERIAL
6MM AND 8MM	ADJUSTABLE 2.4 N.cm TO 132.4 N.cm	HOUSING, ADJUSTER RING AND ADAPTERS - ALUMINUM WITH ALOCROM FINISH, HUBS AND PLATES - HEAT TREATED STEEL, BEARING - SINTERED BRONZE

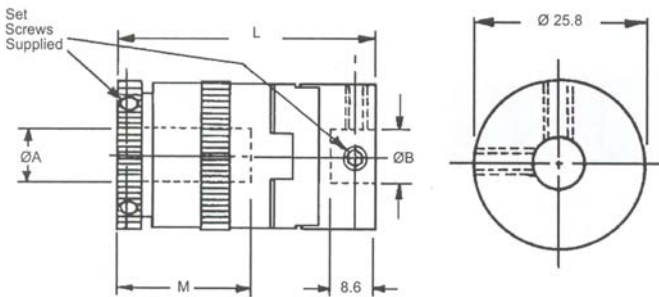

STOCK NO.	ØA BORE +0.03	ØB BORE +0.03	L	M	ADJUSTABLE TORQUE RANGE N*cm		WEIGHT
					MIN.	MAX.	
JJ-29M JJ-30M	6.00 8.00	6.00 8.00	46.5	25.0	2.4	53.0	57g
JJ-31M JJ-32M	6.00 8.00	6.00 8.00	53.4	31.0	7.8	132.4	68g

- Bi-directional
- Maximum operating Temperature 80°C
- Maximum backlash 2°

# SLIP COUPLINGS

BORE	MATERIAL
3MM TO 19MM	STAINLESS STEEL DIN 1.4305

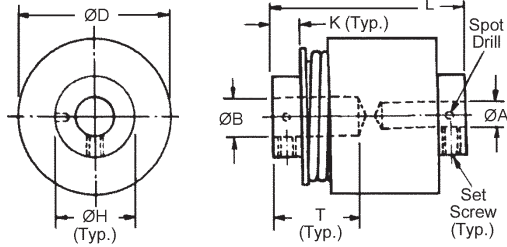

- Shaft misalignment to 0.3 max.
- Angular misalignment 3° maximum.

STOCK NUMBER.	BORE		L ±0.5	ØD ±0.05	ØH ±0.05	K ±0.05	T	TORQUE BI-DIRECTION N•cm
	ØA	+0.015 -0.000 ØB.						
JJM-1	3.000	3.000	22.6	12.7	9.4	4.3	10.9	3.5 ± 0.5
JJM-2	3.000	4.000						
JJM-3	4.000	4.000						
JJM-4	4.000	4.000	28.2	19.1	12.7	4.8	12.7	8.5 ± 0.8
JJM-5	4.000	6.000						
JJM-6	6.000	6.000						
JJM-7	4.000	4.000	32.0	25.4	12.7	4.8	14.0	14.1 ± 1.4
JJM-8	4.000	6.000						
JJM-9	6.000	6.000						
JJM-10	6.000	6.000	36.3	31.8	15.7	6.4	15.7	33.9 ± 3.5
JJM-11	6.000	10.000						
JJM-12	10.000	10.000						
JJM-13	8.000	8.000	40.4	38.1	19.1	6.4	18.5	62.2 ± 6.4
JJM-14	10.000	10.000						
JJM-15	10.000	10.000	46.7	47.5	22.1	7.1	21.6	84.7 ± 8.5
JJM-16	10.000	12.000						
JJM-17	12.000	12.000						
JJM-18	10.000	10.000	57.2	57.2	38.1	9.7	25.4	169.5 ± 16.9
JJM-19	10.000	12.000						
JJM-20	12.000	12.000						
JJM-21	12.000	16.000						
JJM-22	16.000	16.000						
JJM-23	16.000	19.000						
JJM-24	19.000	19.000						

Available On Request: Torque Limits Calibrated to 5%  
Torque From 0.35 N•mc To 340 N•mc

# SLIP COUPLINGS

BORE	TORQUE	MATERIAL
3MM TO 19MM	ADJUSTABLE 0 N.cm TO 35.5 N.cm	STAINLESS STEEL HOUSING

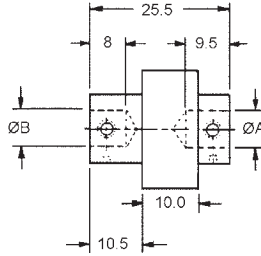
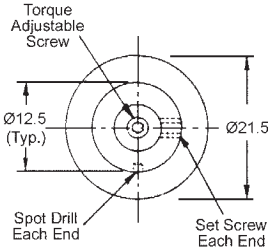

- Bi-directional
- No lubrication required
- Rulon clutch faces for smooth operation and long life at high speeds
- Consistent breakaway torques and performance at slip speeds up to 1200 R.P.M.
- Slip torque is set and may be adjusted

STOCK NUMBER	ØA BORE +0.013	ØB BORE +0.013	ADJUSTABLE TORQUE RANGE
JKM-1	4.000	4.000	0 To 35.5 N*cm
JKM-2	4.000	5.000	
JKM-3	4.000	6.000	
JKM-4	5.000	5.000	
JKM-5	5.000	6.000	
JKM-6	6.000	6.000	
JKM-7	6.000	6.000	

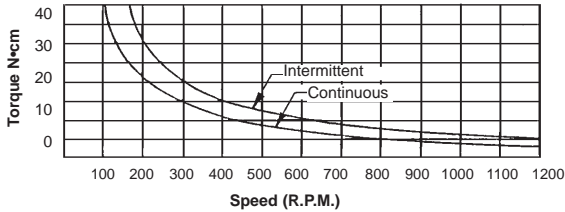

Note: Clutch capacity can be determined by use of the chart. The curves are based on a predetermined maximum temperature rise in the clutch when operated in an ambient temperature of 20°C. The intermittent curve applies to applications where the slipping period is 10 minutes or less and the cooling period is equal or greater.

Torque settings are maintained within plus or minus 20% over the full speed range. Stability is improved for constant speed applications.

# OVERRUNNING COUPLING

BORE	STYLE	MATERIAL
4MM TO 13MM	CLOCKWISE SPRING WRAPPED - ONE DIRECTIONAL	STAINLESS STEEL DIN 1.4005 HUB DELTRIN CENTER

STOCK NO.	+0.015 ØA	+0.015 ØB	MAX DRIVE TORQUE	MAX DRAG TORQUE	C	ØD	ØE	F	H
JBM-R-1	3.995	3.995	113 N•cm	1.1 N•cm	25.0	19.0	14.0	5.4	12
JBM-R-2	3.995	4.995							
JBM-R-3	3.995	5.995							
JBM-R-4	4.995	4.995							
JBM-R-5	4.995	5.995							
JBM-R-6	5.995	5.995							
JBM-R-7	7.995	7.995	904 N•cm	2.8 N•cm	2.8	35.0	25.0	8.4	18.5
JBM-R-8	7.995	9.995							
JBM-R-9	7.995	12.995							
JBM-R-10	9.995	9.995							
JBM-R-11	9.995	12.995							
JBM-R-12	12.995	12.995							

Locking R.H. Hub, L.H. Hub drives clockwise.

BORE	STYLE	MATERIAL
4MM TO 13MM	COUNTER-CLOCKWISE SPRING WRAPPED - ONE DIRECTIONAL	STAINLESS STEEL DIN 1.4005 HUB DELTRIN CENTER

STOCK NO.	+0.015 ØA	+0.015 ØB	MAX DRIVE TORQUE	MAX DRAG TORQUE	C	ØD	ØE	F	H
JBM-L-1	3.995	3.995	113 N•cm	1.1 N•cm	25.0	19.0	14.0	5.4	12
JBM-L-2	3.995	4.995							
JBM-L-3	3.995	5.995							
JBM-L-4	4.995	4.995							
JBM-L-5	4.995	5.995							
JBM-L-6	5.995	5.995							
JBM-L-7	7.995	7.995	904 N•cm	2.8 N•cm	2.8	35.0	25.0	8.4	18.5
JBM-L-8	7.995	9.995							
JBM-L-9	7.995	12.995							
JBM-L-10	9.995	9.995							
JBM-L-11	9.995	12.995							
JBM-L-12	12.995	12.995							

Locking R.H. Hub, L.H. Hub drives clockwise.

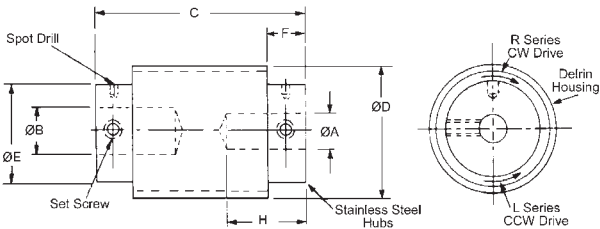

Drive load in one direction.  
Clutch rotates freely in opposite direction  
Note: Backlash is less than 1° (degree) in driving direction.



# INLINE COUPLING SLIP CLUTCH

BORE	STYLE	TORQUE	MATERIAL
4MM TO 6MM	PIN HUB	ADJUSTABLE 0 N.cm TO 17 N.cm	STAINLESS STEEL DIN 1.4305

STOCK NO.	ØB1* +0.013	ØB2 +0.013	ØH	ADJUSTABLE SLIP TORQUE
CO16M-1	3.995	3.995	8	0 TO 17 N*cm
CO16M-2	4.995	4.995	10	
CO16M-3	5.995	5.995	13	
CO16M-4	3.995	4.995	10	
CO16M-5	3.995	5.995	13	
CO16M-6	4.995	5.995	13	

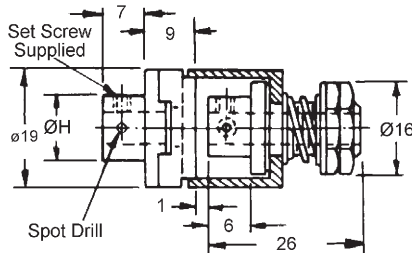

PIN HUB

BORE	STYLE	TORQUE	MATERIAL
4MM TO 6MM	CLAMP HUB	ADJUSTABLE 0 N.cm TO 17 N.cm	STAINLESS STEEL DIN 1.4305

STOCK NO.	ØB1* +0.013	ØB2 +0.013	ØC	ADJUSTABLE SLIP TORQUE
CO17M-1	3.995	3.995	5	0 TO 17 N*cm
CO17M-2	4.995	4.995	7	
CO17M-3	5.995	5.995	8	
CO17M-4	3.995	4.995	7	
CO17M-5	3.995	5.995	8	
CO17M-6	4.995	5.995	8	

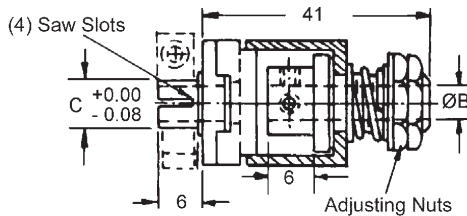

CLAMP HUB

\* Bore size on adjustable end.  
Other bore combinations on request.  
For 35 N\*cm units, add -35 to stock number.

# SLIP CLUTCH

BORE	STYLE	TORQUE	MATERIAL
4MM TO 6MM	PIN HUB	ADJUSTABLE 0 N.cm TO 35 N.cm	STAINLESS STEEL DIN 1.4305

STOCK NO.	BORE SIZE	ØH	ØD	ADJUSTABLE SLIP TORQUE
JCM-10 JCM-11 JCM-12	3.995 4.995 5.995	8 10 13	15	0 TO 7 N*cm
JCM-10-50 JCM-11-50 JCM-12-50	3.995 4.995 5.995	8 10 13	15	7 TO 35 N*cm
JAM-1 JAM-2 JAM-3	3.995 4.995 5.995	8 10 13	25	7 TO 35 N*cm
JCM-1 JCM-2 JCM-3	3.995 4.995 5.995	8 10 13	25	0 TO 7 N*cm
JCM-1-50 JCM-2-50 JCM-3-50	3.995 4.995 5.995	8 10 13	25	7 TO 35 N*cm

BORE	STYLE	TORQUE	MATERIAL
4MM TO 6MM	CLAMP HUB	ADJUSTABLE 0 N.cm TO 35 N.cm	STAINLESS STEEL DIN 1.4305

STOCK NO.	BORE SIZE	ØC	ØD	ADJUSTABLE SLIP TORQUE
JAM-1C JAM-2C JAM-3C	3.995 4.995 5.995	8 10 13	25	7 TO 35 N*cm
JCM-1C JCM-2C JCM-3C	3.995 4.995 5.995	8 10 13	25	0 TO 7 N*cm
JCM-1-50C JCM-2-50C JCM-3-50C	3.995 4.995 5.995	8 10 13	25	7 TO 35 N*cm

CLAMP HUB      PIN HUB

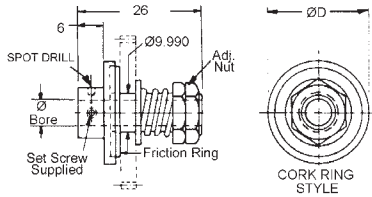
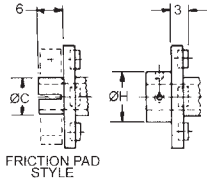

Order gears and clamps separately.

# SLIP CLUTCH

BORE	STYLE	TORQUE	MATERIAL
4MM TO 6MM	CLAMP HUB	ADJUSTABLE 0 N.cm TO 70 N.cm	STAINLESS STEEL DIN 1.4305

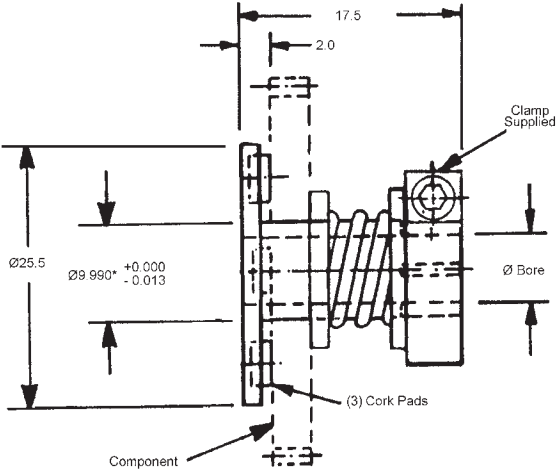

- Use with gears, sprockets, pulleys, ratchets, cams, or other components with 10mm bores.

STOCK NO.	BORE	COMPONENT THICKNESS (IN.)	ADJUSTABLE SLIP TORQUE (IN.)
JCM-7	3.995	1.5 THROUGH 3.0	1.5, 0-10 N•cm 3.0, 3-20 N•cm
JCM-8	4.995		
JC-M9	5.995		
JC-7M-50	3.995	1.5 THROUGH 3.0	1.5, 10-35 N•cm 3.0, 18-70 N•cm
JC-8M-50	4.995		
JC-9M-50	5.995		

\* Adjustable by varying spring force

G

# SLIP CLUTCH

BORE	TORQUE	MATERIAL
6MM OR 8MM	ADJUSTABLE 2.5 N.cm TO 132 N.cm	HOUSING, ADJUSTOR RING & ADAPTERS-ALUMINUM HUB & PLAES-STEEL, BEARING-SINTERED BRONZE

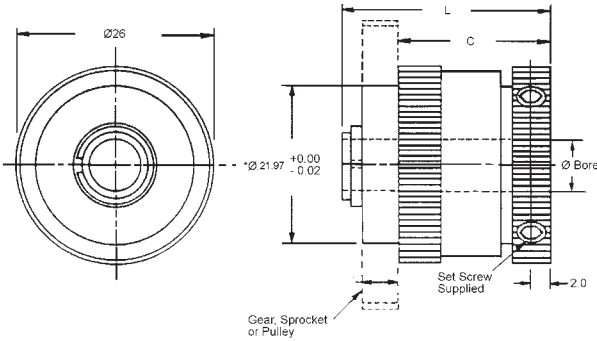

STOCK NO.	$\varnothing$ BORE +0.03	L	C	ADJUSTABLE TORQUE RANGE		WEIGHT
				MIN.	MAX.	
JH-11M	6.00	26.4	20.0	2.5 N•cm	53.5 N•cm	37g
JH-12M	8.00					
JH-13M	6.00	32.4	25.6	7.8 N•cm	132.0 N•cm	48g
JH-14M	8.00					

- Maximum operating temperature 80°C
- Maximum backlash 2°
- Bi-directional
- Fine-knurled torque adjustment rings

# SLIP CLUTCH

BORE	STYLE	MATERIAL
3MM TO 12MM	1 AND 2	STAINLESS STEEL BRONZE BEARINGS

STOCK NO.	ØB BORE +0.02 -0.00	TORQUE BI-DIRECTIONAL	ØK DIA. -0.02	L	A	C	STYLE	ØD	T THREAD (DEPTH)	ØB.C.	F	ØQ (MAX.)	E	ØH
JH-1M	3.00	6.4 N•cm ± 0.7	10.00	26.7	18.3	4.6	1	16	M1.2 X 2.5 X 2.0Dp.	12	2.0	11.4	0.8	10
JH-2M	4.00	14.1 N•cm ± 1.4	12.00	31.5	21.6	5.3	1	25	M1.2 X 2.5 X 2.0Dp.	16	2.4	17.3	1.0	13
JH-2AM	6.00	14.1 N•cm ± 1.4	12.00	31.5	21.6	5.3	1	25	M1.2 X 2.5 X 2.0Dp.	16	2.4	17.3	1.0	13
JH-3M	6.00	33.9 N•cm ± 3.5	12.00	35.3	23.9	5.8	1	35	M2.0 X 0.4 X 2.5Dp.	25	3.3	17.3	1.0	13
JH-4M	6.00	56.5 N•cm ± 5.7	12.00	35.3	23.9	5.8	2	35	M2.0 X 0.4 X 2.5Dp.	25	3.3	17.3	1.0	16
JH-5M	6.00	84.7 N•cm ± 8.5	12.00	42.4	30.5	6.4	1	48	M2.0 X 0.4 X 2.5Dp.	20	3.3	17.3	1.0	16
JH-5AM	8.00	84.7 N•cm ± 8.5	12.00	42.4	30.5	6.4	1	48	M2.0 X 0.4 X 2.5Dp.	20	3.3	17.3	1.0	25
JH-6M	10.00	105.9 N•cm ± 10.6	20.00	47.8	34.0	7.4	1	48	M2.0 X 0.4 X 2.5Dp.	30	3.3	18.8	1.0	25
JH-6AM	12.00	105.9 N•cm ± 10.6	20.00	47.8	34.0	7.4	1	48	M2.0 X 0.4 X 2.5Dp.	30	3.3	18.8	1.0	25
JH-7M	6.00													
JH-8M	8.00													
JH-9M	10.001	169.5 N•cm ± 17.0	20.00	47.8	34.0	7.4	2	57	M3.0 X 0.5 X 4.0Dp.	30	3.3	18.8	1.0	25
JH-10M	12.00													
JH-7M-X	6.00													
JH-8M-X	8.00													
JH-9M-X	10.001	226 N•cm ± 23.0	20.00	47.8	34.0	7.4	2	57	M3.0 X 0.5 X 4.0Dp.	30	3.3	18.8	1.0	25
JH-10M-X	12.00													

- Torque limits calibrated to 5% on request.
- Torques from 0.35 N.cm to 339 N.cm are available on request.

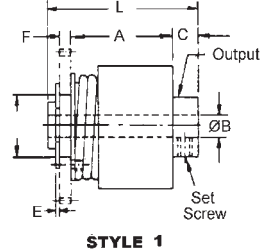
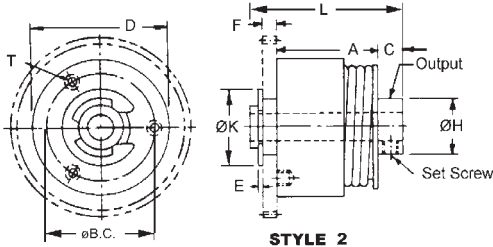

# MINIATURE SLIP CLUTCH

BORE	STYLE	TORQUE	MATERIAL
4MM TO 5MM	CLAMP HUB	ADJUSTABLE 0 N.cm TO 35.5 N.cm	ANODIZED ALUMINUM

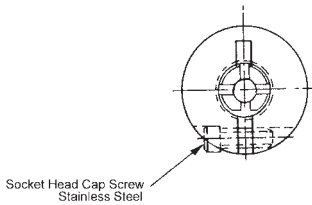
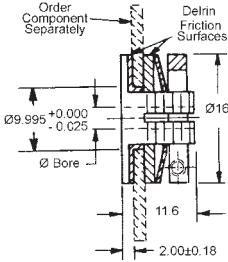

STOCK NO.	$\varnothing$ BORE +0.005	COMPONENT THICKNESS
JAM-4	3.995	1.5 THROUGH 3.0
JAM-5	4.995	

- Use with gears, sprockets, pulleys, ratchets, cams, or other components with 10mm bores.

Special bore sizes available on request.

- \* Adjustable by varying spring force

# SLIP CLUTCHES AND COUPLINGS

BORE	STYLE	TORQUE	MATERIAL
3MM TO 12MM	OPEN OR CLOSED	ADJUSTABLE 3.4 N.cm TO 280 N.cm	HOUSING, ADJUSTER RING AND ADAPTERS - ALUMINUM; ALOCROM FINISH, HUBS; PLATES - HEAT TREATED STEEL; BEARING - SINTERED BRONZE

SLIP CLUTCH STOCK NO.	SLIP COUPLING STOCK NO.	$\varnothing B$ +0.03	$\varnothing A$	C	$\varnothing D$	E	$\varnothing G$	ADJUSTABLE TORQUE RANGE	STYLE
JCL-1M JCL-2M JCL-3M	JCO-1M JCO-2M JCO-3M	3 4 6	25	33	10	6	18	3.4 TO 113 N•cm	CLOSED
JCL-4M JCL-5M JCL-6M	JCO-4M JCO-5M JCO-6M	6 8 12	38	64	25	10	30	5.6 TO 280 N•cm	OPEN

SLIP COUPLING  
JCO SERIES - CLOSED

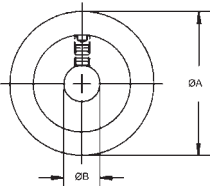

SLIP CLUTCH  
JCL SERIES - CLOSED

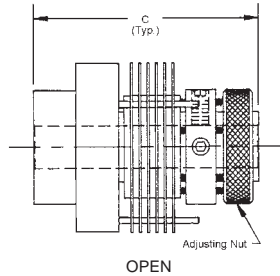
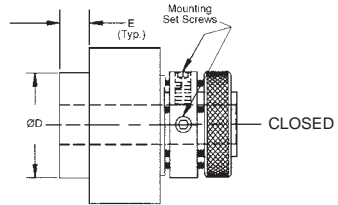
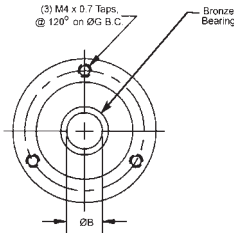

# ROLLER CLUTCHES

BORE	STYLE	MATERIAL
4MM TO 20MM	DRAWN CUP DESIGN ONE DIRECTIONAL DRIVE	ROLLER CUP - CASE HARDENED STEEL; NEEDLE BEARINGS - HARDENED CHROME STEEL DIN 1.3505; SPRINGS - STAINLESS STEEL; CAGE - NYLON 66 (or Equiv.) TREATED STEEL; BEARING - SINTERED BRONZE

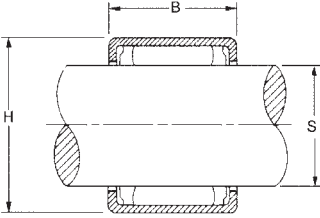

- Ideal For Indexing, Backstopping Or Overrunning Operations
- Free Rolling One Way, Drives In Opposite Direction
- Light Weight, Low Profile
- High Indexing, Frequency
- Temp. Range, Grease - 45P C to + 70PC
- Minimum Backlash

Shaft  
Drives Gear  
Clockwise

Gear Can Drive  
Shaft Counter-Clockwise

Shaft Overruns in Gear  
Counter-Clockwise Or  
Gear Overruns On Shaft Clockwise

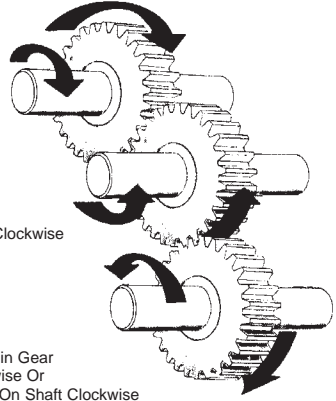

\* HARDENED SHAFTING  
STOCK LENGTH 300mm  
OTHER LENGTHS ON  
REQUEST

SHAFTING STOCK NO.	SHAFT DIAMETER h6
LMS-6M	6.000
LMS-8M	8.000
LMS-12M	12.000
LMS-20M	20.000

STOCK NO.	BORE ØS	ØH CLUTCH O.D.	B +0.00 -0.08	MAX TORQ N*cm	HOUSING DIAMETER N7 STEEL R7 ALUM.	OVERRUN SPEED (MAX) (RPM)
NRC-4M*	4	8.000	6.00	0.34	8.000	17000
NRC-6M	6	10.000	12.00	1.76	10.000	23060
NRC-8M	8	12.000	12.00	3.15	12.000	17000
NRC-10M	10	14.000	12.00	5.30	14.000	14000
NRC-12M	12	18.000	16.00	12.20	18.000	11000
NRC-20M	20	26.000	16.00	28.50	26.000	7000

\* Order Shaft Separately.

- Maximum operating temperature +70°C due to plastic spring design.